

User's Manual

Communication IP Camera

Model No. **KX-NTV150**

IP Video Doorphone

Model No. **KX-NTV160**

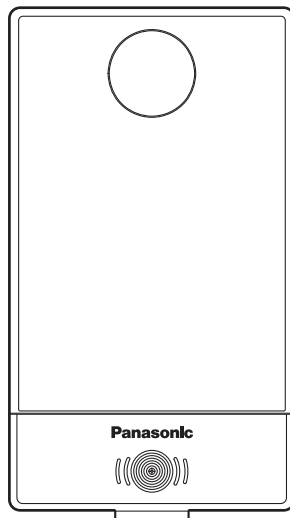

KX-NTV150

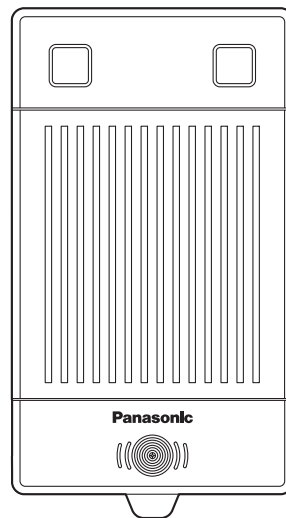

KX-NTV160

Thank you for purchasing this Panasonic product.
Please read this manual carefully before using this product and save this manual for future use.

Preface

Outline

This manual describes information about the installation and operation of KX-NTV150 and KX-NTV160.

Note

- In this manual, the suffix of each model number is omitted unless necessary.
- The illustration such as some keys may differ from the appearance of the actual product.
- Certain products and features described in this document may not be available in your country or area. Contact your phone system dealer/service provider.
- The contents and design of the software are subject to change without notice.
- The screen shots shown in this manual are provided for reference only, and may differ from the screens displayed on your PC.

Related Documentation

- **Quick Installation Guide**

Describes basic information about the installation and safety precautions to prevent personal injury and/or damage to property.

- **Installation Wizard User's Manual**

Describes detailed information about the Installation Wizard.

Manuals and supporting information are provided on the Panasonic Web site at:

<http://www.panasonic.net/pcc/support/pbx/>

Trademarks

- QuickTime, and the QuickTime Logo are trademarks of Apple Inc., registered in the U.S. and other countries.
- ActiveX, Microsoft, Windows, and Internet Explorer are either registered trademarks or trademarks of Microsoft Corporation in the United States and/or other countries.
- Mozilla and Firefox are registered trademarks of the Mozilla Foundation.
- UPnP is a certification mark of UPnP Forum in the United States and other countries.
- Wi-Fi, WPA, and WPA2 are registered trademarks or trademarks of Wi-Fi Alliance.
- All other trademarks identified herein are the property of their respective owners.
- Microsoft product screen shot(s) reprinted with permission from Microsoft Corporation.

AVC/H.264 Visual License

THIS PRODUCT IS LICENSED UNDER THE AVC PATENT PORTFOLIO LICENSE FOR THE PERSONAL USE OF A CONSUMER OR OTHER USES IN WHICH IT DOES NOT RECEIVE REMUNERATION TO (i) ENCODE VIDEO IN COMPLIANCE WITH THE AVC STANDARD ("AVC VIDEO") AND/OR (ii) DECODE AVC VIDEO THAT WAS ENCODED BY A CONSUMER ENGAGED IN A PERSONAL ACTIVITY AND/OR WAS OBTAINED FROM A VIDEO PROVIDER LICENSED TO PROVIDE AVC VIDEO. NO LICENSE IS GRANTED OR SHALL BE IMPLIED FOR ANY OTHER USE. ADDITIONAL INFORMATION MAY BE OBTAINED FROM MPEG LA, L.L.C. SEE [HTTP://WWW.MPEGLA.COM](http://WWW.MPEGLA.COM)

For Future Reference

Record the information in the space below for future reference.

Note

- The serial number and MAC address of this product may be found on the label affixed to the bottom of the unit. You should note the serial number and MAC address of this unit in the space provided and retain this manual as a permanent record of your purchase to aid in identification in the event of theft.

MODEL NO.	_____
SERIAL NO.	_____
MAC ADDRESS	_____
DATE OF PURCHASE	_____
NAME OF DEALER	_____
DEALER'S ADDRESS	_____

DEALER'S TEL. NO.	_____

Important Information

Data Security

- To avoid unauthorized access to this product:
 - Keep the password (e.g., PIN for registration) secret.
 - Change the default password.
 - Set a password that is random and cannot be easily guessed.
 - Change the password regularly.

Disposal of Old Equipment and Batteries Only for European Union and countries with recycling systems

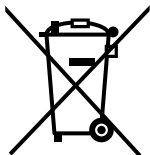

These symbols on the products, packaging, and/or accompanying documents mean that used electrical and electronic products and batteries must not be mixed with general household waste.

For proper treatment, recovery and recycling of old products and batteries, please take them to applicable collection points, in accordance with your national legislation.

By disposing of them correctly, you will help to save valuable resources and prevent any potential negative effects on human health and the environment.

For more information about collection and recycling, please contact your local municipality. Penalties may be applicable for incorrect disposal of this waste, in accordance with national legislation.

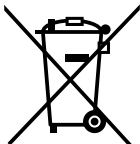

Note for the battery symbol (bottom symbol)

This symbol might be used in combination with a chemical symbol. In this case it complies with the requirement set by the Directive for the chemical involved.

For Users in European Countries

The following declaration is applicable to KX-NTV150NE only

CE 0560

This device is a Communication IP Camera operating in the frequency band of 2412 MHz to 2472 MHz. The usage of this device is generally allowed in all EU countries.

Panasonic System Networks Co., Ltd. declares that this equipment is in compliance with the essential requirements and other relevant provisions of Radio & Telecommunications Terminal Equipment (R&TTE) Directive 1999/5/EC.

Declarations of Conformity for the relevant Panasonic products described in this manual are available for download by visiting:

<http://www.ptc.panasonic.eu>

Contact to Authorized Representative:
 Panasonic Testing Center
 Panasonic Marketing Europe GmbH
 Winsbergring 15, 22525 Hamburg, Germany

The following declaration is applicable to KX-NTV160NE only



For information of Compliance with EU relevant Regulatory Directives, contact to Authorized Representative:
 Panasonic Testing Center
 Panasonic Marketing Europe GmbH
 Winsbergring 15, 22525 Hamburg, Germany

Ecodesign information

Ecodesign information under EU Regulation (EC) No.1275/2008 amended by (EU) Regulation No. 801/2013.

=====

Please visit here: www.ptc.panasonic.eu
 Click [Downloads]
 → Energy related products information (Public)

=====

Power consumption in networked standby and guidance are mentioned in the web site above.

For Users in the United States

FCC and Other Information

Privacy of communications may not be ensured when using this product.

FCC RF Exposure Warning:

- This product complies with FCC radiation exposure limits set forth for an uncontrolled environment.
- To comply with FCC RF exposure requirements, the product must be installed and operated 20 cm (8 inches) or more between the product and all person’s body.
- This product may not be collocated or operated in conjunction with any other antenna or transmitter.

FCC ID can be found on the bottom of the units.

Note

- This equipment has been tested and found to comply with the limits for a Class B digital device, pursuant to Part 15 of the FCC Rules. These limits are designed to provide reasonable protection against harmful interference in a residential installation. This equipment generates, uses, and can radiate radio frequency energy and, if not installed and used in accordance with the instructions, may cause harmful interference to radio communications. However, there is no guarantee that interference will not occur in a particular installation. If this equipment does cause harmful interference to radio or television reception, which can be determined by turning the equipment off and on, the user is encouraged to try to correct the interference by one or more of the following measures:
 - Reorient or relocate the receiving antenna.
 - Increase the separation between the equipment and receiver.
 - Connect the equipment to an outlet on a circuit different from that to which the receiver is connected.
 - Consult the dealer or an experienced radio/TV technician for help.

Important Information

This device complies with Part 15 of the FCC Rules. Operation is subject to the following two conditions: (1) this device may not cause harmful interference, and (2) this device must accept any interference received, including interference that may cause undesired operation.

CAUTION

Any changes or modifications not expressly approved by the party responsible for compliance could void the user's authority to operate this product.

Technical Support

Panasonic Corporation of North America
Two Riverfront Plaza, Newark, NJ 07102-5490
Telephone: 1 (800) 528-6747 Option 1

For Users in Canada

Industry Canada Notices and Other Information

This product meets the applicable Industry Canada technical specifications.

Note

- This device complies with Industry Canada licence-exempt RSS standard(s). Operation is subject to the following two conditions: (1) this device may not cause interference, and (2) this device must accept any interference, including interference that may cause undesired operation of the device.
- Privacy of communications may not be ensured when using this product.
- Some wireless products operate at frequencies that may cause interference to nearby TVs and VCRs. To minimize or prevent such interference, the wireless product should not be placed near, or on top of, a TV or VCR. If interference is experienced, move the wireless product farther away from the TV or VCR. This will often reduce, or eliminate, interference.
- This transmitter must not be co-located or operated in conjunction with any other antenna or transmitter.
- This Class B digital apparatus complies with Canadian ICES-003.

CAUTION

Any changes or modifications not expressly approved by the party responsible for compliance could void the user's authority to operate this product.

RF Exposure Warning:

- This product complies with IC radiation exposure limits set forth for an uncontrolled environment.
- To comply with IC RF exposure requirements, the product must be installed and operated 20 cm (8 inches) or more between the product and all person's body.
- This product may not be collocated or operated in conjunction with any other antenna or transmitter.

For Users in Taiwan

1. Without grant permission, the frequency change, power enhance or alter of original design characteristic as well as function by company, enterprise, or user for approved Radio-frequency Telecommunications terminal equipment is not allowed.
2. Radio-frequency telecommunications terminal equipment shall not influence aircraft security and interfere legal communications; if found, shall cease operating immediately until no interference is achieved. Aforesaid Legal Communications is defined as radio communications operation follows "Telecommunications Act"

3. The imported, manufactured Radio-frequency Telecommunications terminal equipment violate this regulations due to unapproved use or radio frequency, electrical power modified.
The company, enterprise, or users is not only punished as per regulations of "Telecommunications Act", but also revoked of approved certificate.

For Users in Argentina

CONDITION OF OPERATION

The operation of this equipment is conditioned to that they do not produce detrimental interference on other radio electric systems authorized. In addition of that, there is not going to be place to complaints because of interferences caused by stations authorized on this systems.

PRIVACY OF THE COMMUNICATIONS

With the use of this system, the privacy of the communications, is not this guaranteed against clandestine listening.

The digital technology of expanded spectrum reduces the possibility of illegal listening to protect its privacy.

For Best Performance

Noise

Occasional noise or interference may occur due to electromagnetic radiation from objects such as refrigerators, microwave ovens, faxes, TVs, radios, or personal computers. If noise disturbs your calls, keep the product away from these electrical appliances.

Environment

- Keep the product away from heating appliances and devices that generate electrical noise, such as fluorescent lamps and motors. These noise sources can interfere with performance of the product.
- Do not place the product in places where the temperatures out of the range of product spec.
KX-NTV150: 0 °C to 40 °C
KX-NTV160: -10 °C to 50 °C
- Allow 10 cm (3 15/16 inches) clearance around the product for proper ventilation.
- Avoid environments with excessive smoke, dust, moisture, mechanical vibration, shock, or direct sunlight.
- The apparatus is designed to be installed and operated under controlled conditions of ambient temperature and a relative humidity.

Routine Care

- Unplug the AC adaptor from the AC outlet and disconnect the Ethernet cable before cleaning.
- Wipe the product with a soft cloth.
- Do not clean the product with abrasive powder or with chemical agents such as benzine or thinner.
- Do not use liquid cleaners or aerosol cleaners.
- Clean the terminal of the charger periodically.

Placement

- Do not place heavy objects on top of the product.
- Do not place the product around heat sources, such as a television or oven.
- Keep the product away from direct sunlight.
- Do not place the product on unsteady surfaces.

Table of Contents

1	Operations	10
1.1	Overview	10
1.2	Read Before Use	11
1.3	Package Contents	12
1.4	Symbols and Statements in this Document	12
1.5	Determining the installation position of the KX-NTV160	13
1.6	Physical Description	14
1.6.1	KX-NTV150	14
1.6.2	KX-NTV160	16
1.6.3	Digital Input/Out Diagram	18
1.6.4	Hardware Reset	19
1.6.5	Network Deployment	20
1.6.6	Registering to a PBX	26
1.7	LED Status	26
1.8	Hardware Key	27
1.9	Communication IP Camera Call (KX-NTV150)	27
1.10	IP Video Doorphone Call (KX-NTV160)	31
2	Software	35
2.1	Software Installation	35
2.2	Accessing the KX-NTV150/KX-NTV160	35
2.3	Change the default password	41
2.4	Main Page	42
2.5	Configuration Area	43
2.6	System	49
2.6.1	General settings	49
2.6.2	Homepage layout	50
2.6.3	Logs	52
2.6.4	Parameters	56
2.7	Maintenance	56
2.7.1	General settings	56
2.7.1.1	Upgrade firmware	56
2.7.1.2	Reboot	58
2.7.1.3	Restore	58
2.8	SIP	61
2.8.1	General Settings	61
2.8.2	SIP Settings	64
2.9	Media	65
2.9.1	Image	65
2.9.2	Video	74
2.9.3	Audio	77
2.10	Network	78
2.10.1	General settings	78
2.10.2	Streaming protocols	83
2.10.3	DDNS	86
2.10.4	QoS (Quality of Service)	87
2.10.5	SNMP (Simple Network Management Protocol)	88
2.11	Wireless	90
2.11.1	WLAN (KX-NTV150 only)	90
2.12	Security	92
2.12.1	User accounts	92
2.12.2	HTTPS (Hypertext Transfer Protocol over SSL)	93

2.12.3	Access List	97
2.12.4	IEEE 802.1X	100
2.13	PTZ	102
2.13.1	PTZ settings	102
2.14	Event	106
2.14.1	Event settings	106
2.15	Applications	116
2.15.1	Motion detection	116
2.15.2	DI and DO	119
2.15.3	Camera tampering detection	120
2.15.4	Voice detection	121
2.16	Recording	122
2.16.1	Recording settings	122
3	Specifications	128
3.1	Technical Specifications	128
3.1.1	General	128
3.1.2	Camera Block	128
3.1.3	Video (Live View Settings)	129
3.1.4	Audio	130
3.1.5	External I/O port	131
3.1.6	SIP Terminal Features	131
4	Appendix	134
4.1	Entering Characters	135

1 Operations

1.1 Overview

KX-NTV150 and KX-NTV160 are designed for SIP communication, which can easily be compatible with existing SIP system, such as Panasonic PBX with SIP protocol. Besides, users can access KX-NTV150/ KX-NTV160 through WEB browser, and other software.

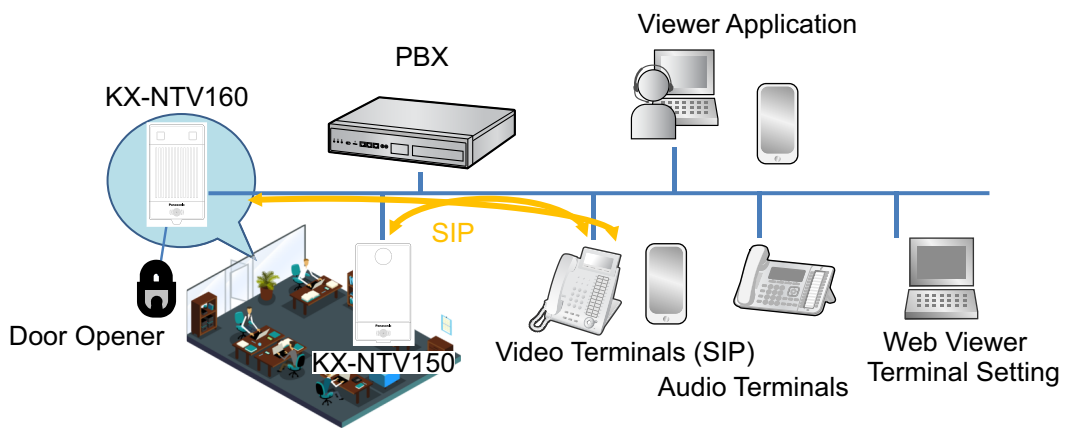

Item	Description
KX-NTV150	Communication IP Camera
KX-NTV160	IP Video Doorphone
Video terminal	SIP Video phone, SIP Soft app
Audio terminal	PBX Audio phone (NT series, DPT, APT, etc.)
Terminal Setting	Setting by KX-NTV150, KX-NTV160 Embedded Web
Web Viewer	Web Viewer by KX-NTV150, KX-NTV160 Embedded Web
Viewer APP	Viewer Application

The below picture shows the appearance of the KX-NTV150. The KX-NTV150 is a Communication IP Camera with Wi-Fi® module; the antenna is hidden inside the housing.

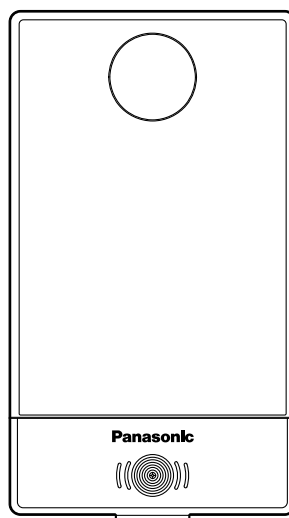

The picture below shows how the appearance of the KX-NTV160. The KX-NTV160 is an IP Video Doorphone with built-in light source LED.

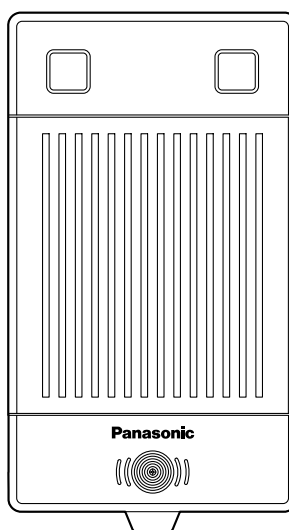

The KX-NTV150/KX-NTV160 support the industry-standard H.264 compression technology, drastically reducing file sizes and conserving valuable network bandwidth. Moreover, the WPS function of KX-NTV150 makes wireless configuration easy and straightforward.



1.2 Read Before Use

The use of surveillance devices may be prohibited by law in your country or area. The KX-NTV150/KX-NTV160 is not only a high-performance web-ready camera but can also be part of a flexible surveillance system. It is the user's responsibility to ensure that the operation of such devices is legal before installing this unit for its intended use.

It is important to first verify that all contents received are complete according to the Package Contents listed below. Take note of the warnings in the Important Information/Quick Installation Guide before the KX-NTV150/KX-NTV160 is installed; then carefully read and follow the instructions in the Installation chapter to avoid damage due to faulty assembly and installation. This also ensures the product is used properly as intended.

1.3 Package Contents

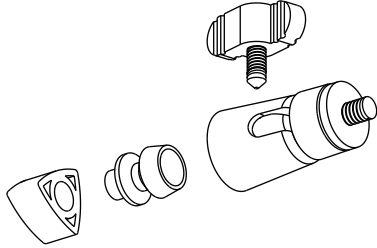
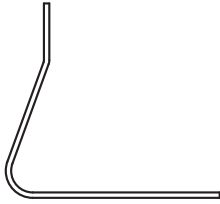
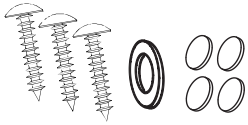
KX-NTV150

Included Accessories	
Attachment kit for the stand: 1 	Camera Stand: 1 
Accessory parts for the stand – Screw for the camera stand wall mounting: 3 – Sponge for camera stand: 1 – Rubber for camera stand: 4 	
Optional Accessories	
AC Adaptor: 1 	KX-A239 (PQLV206) KX-A239BX (PQLV206CE) KX-A239CE (PQLV206CE) KX-A239AL (PQLV206AL) KX-A239UK (PQLV206E) KX-A239EJ (PQLV206E) KX-A239X (PQLV206) KX-A420BR (PSLP1662)

KX-NTV160

Included Accessories	
Wood Screw: 2 	Metal Screw: 2 

1.4 Symbols and Statements in this Document

Important: provides important messages or advice that might help prevent inconvenient or problem situations.
Note: provide guidance or advice that is related to the functional integrity of the machine.



Hints: Hints are useful information that helps enhance or facilitate an installation, function, or process.

1.5 Determining the installation position of the KX-NTV160

Views when the KX-NTV160 is facing forwards at 0°. Example: Installation height is 150 cm (59.1 inches).

- The measurements and angles shown here are for reference purposes and may vary depending on the environment.
- The illustrations below show the maximum area displayed by the KX-NTV160. The actual displayed area depends on the resolution setting used.

Side view

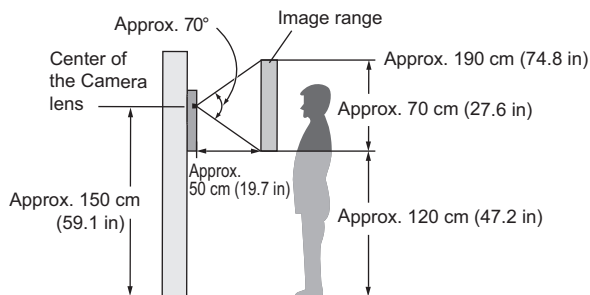

Top view
(view when looking from above)

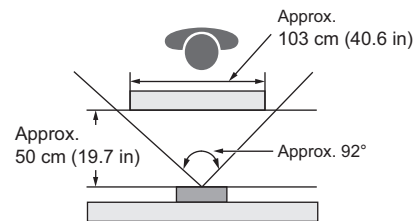

1.6 Physical Description

Note

- Panasonic assumes no responsibility for injuries or property damage resulting from failures arising out of improper installation or operation inconsistent with this documentation.
- When installing the KX-NTV150/KX-NTV160, make sure to remove the protective film from the lens cover.

1.6.1 KX-NTV150

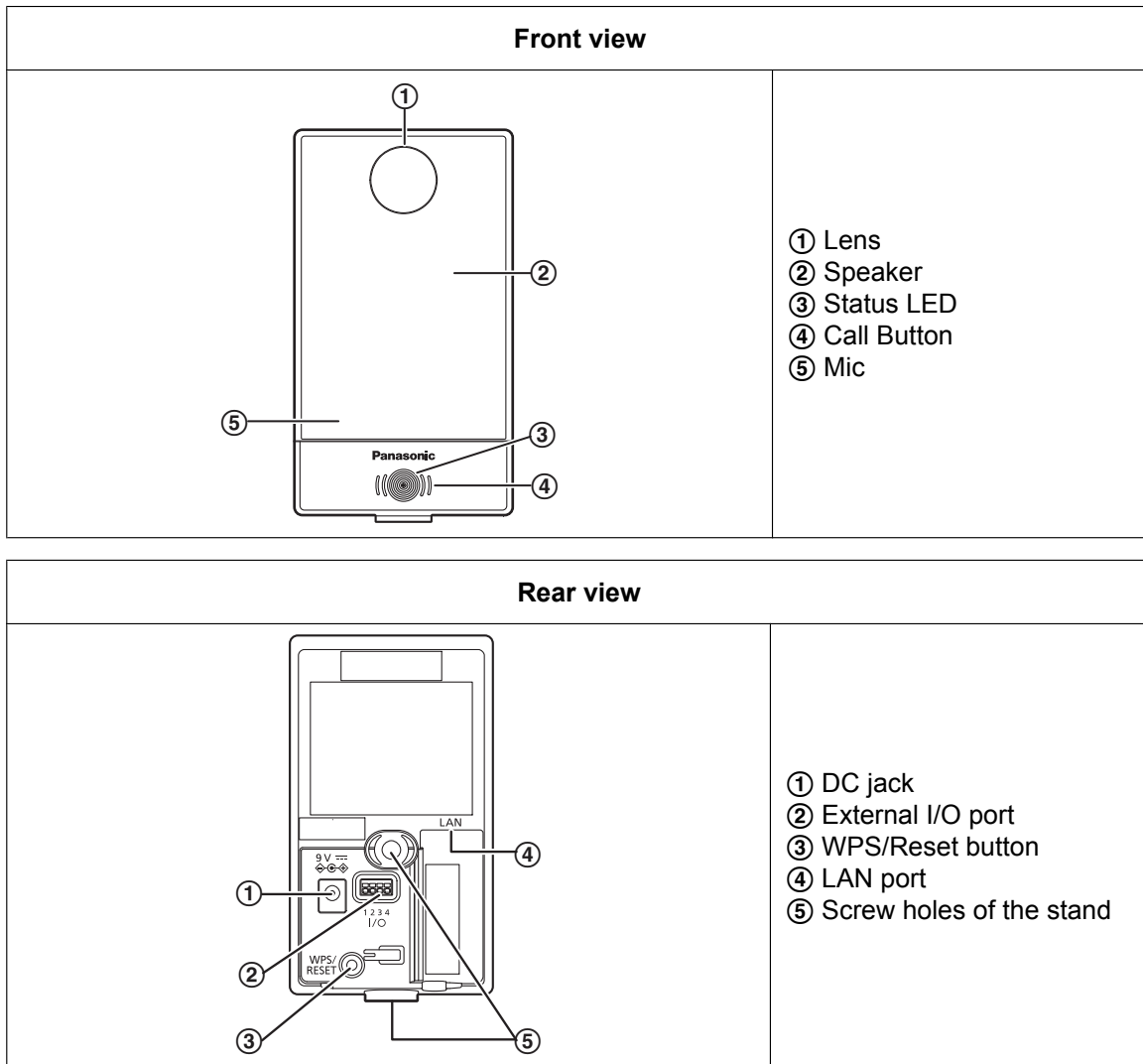

Installing the stand

A. When installing on a flat surface.

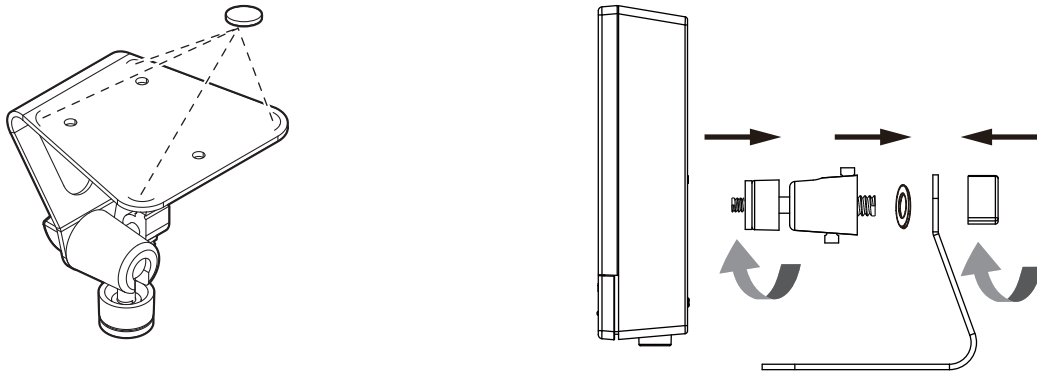

Note

- Use rubber to prevent stand from shifting if necessary. Rubbers should be aligned with the 4 arcs in the corner.

B. When installing on the wall

Note

- Skid proof stickers should be aligned with the 4 arcs in the corner. Attach the camera to stand and orient the shooting angle. If preferred, use the included screws to secure the camera stand to a mounting surface.

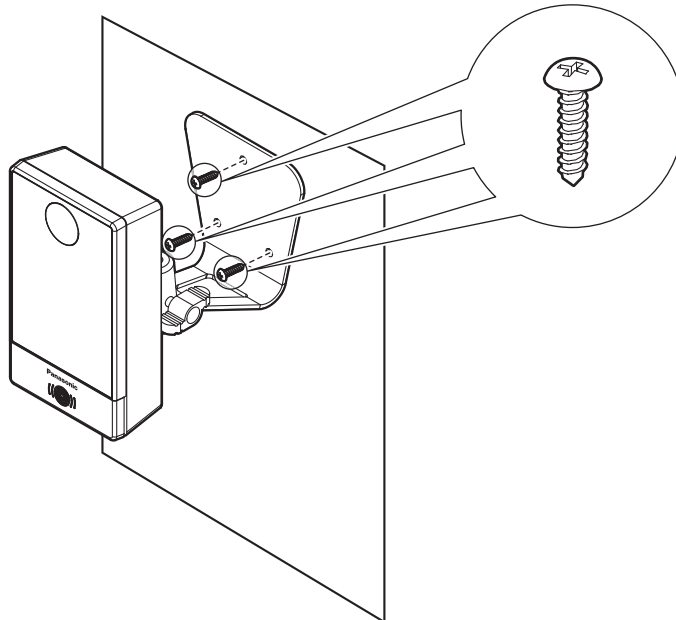

1.6.2 KX-NTV160

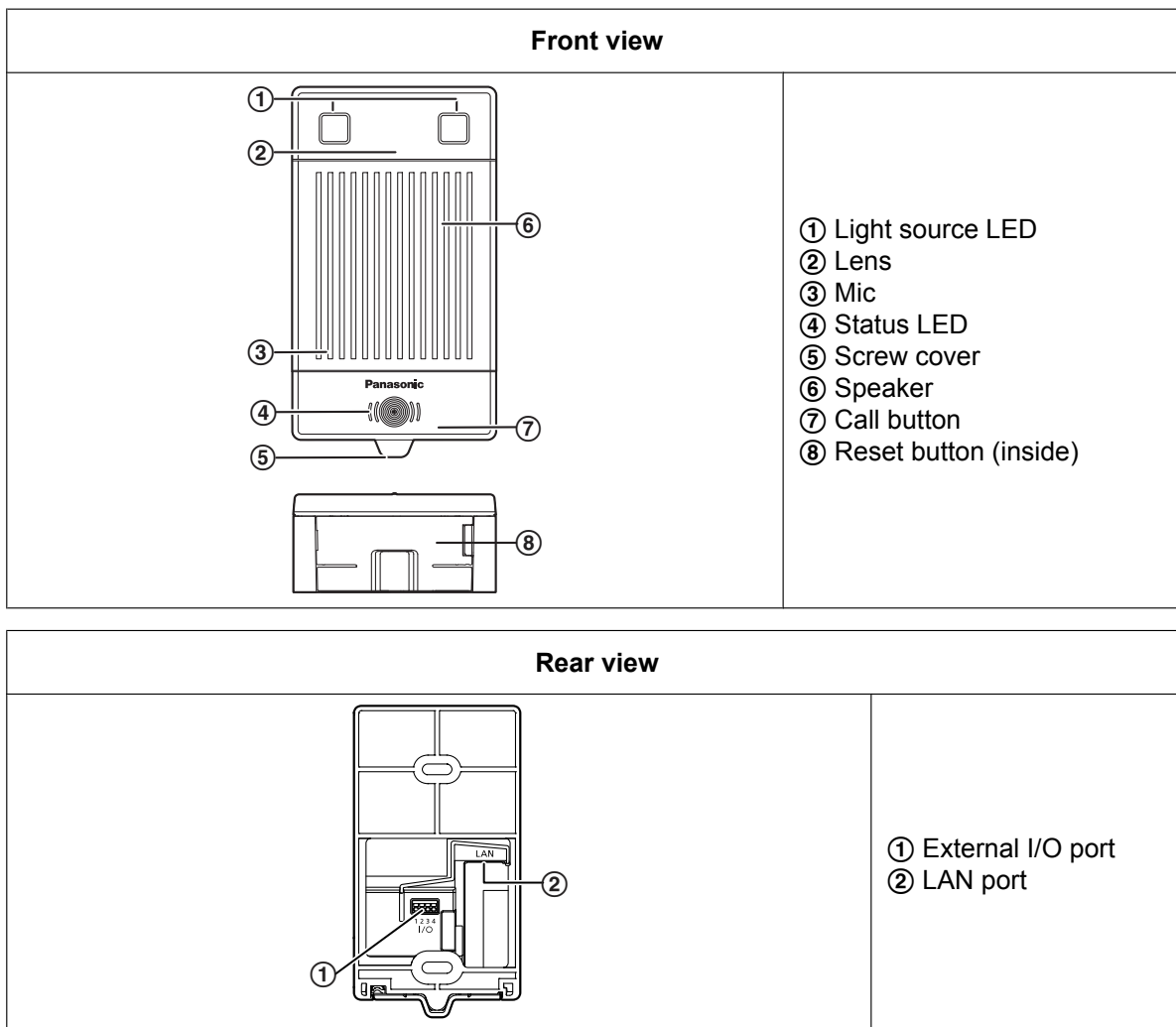

Please install the mounting bases on a vertical flat surface.

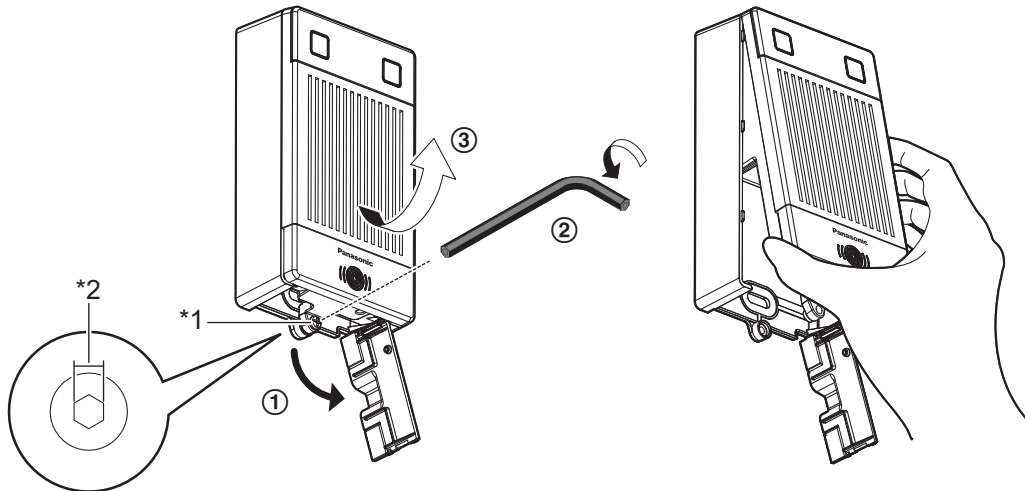

*1 Hexagon socket head screw

*2 2.0 mm (0.07 inch)

A. When installing directly on a wall

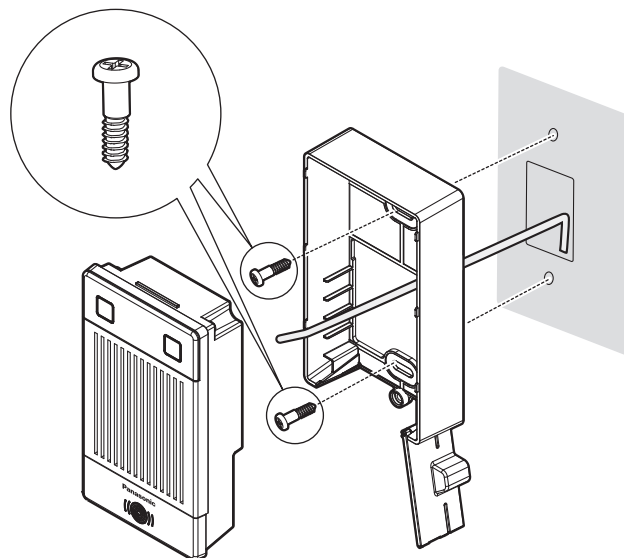

B. When installing with a metal plate

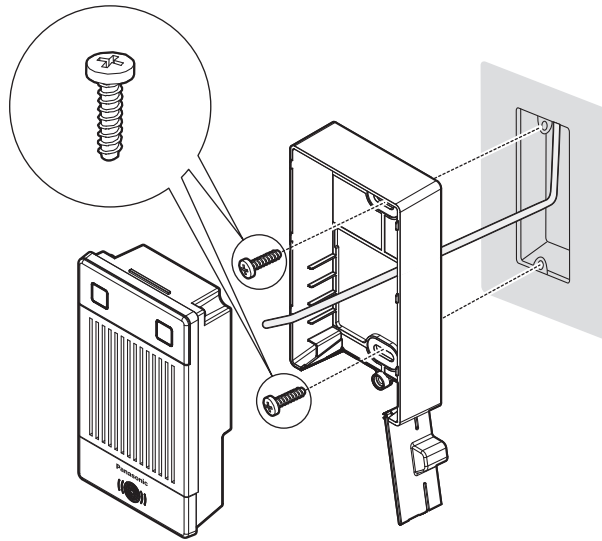

1.6.3 Digital Input/Out Diagram

Please refer to the following illustration for the connection method.

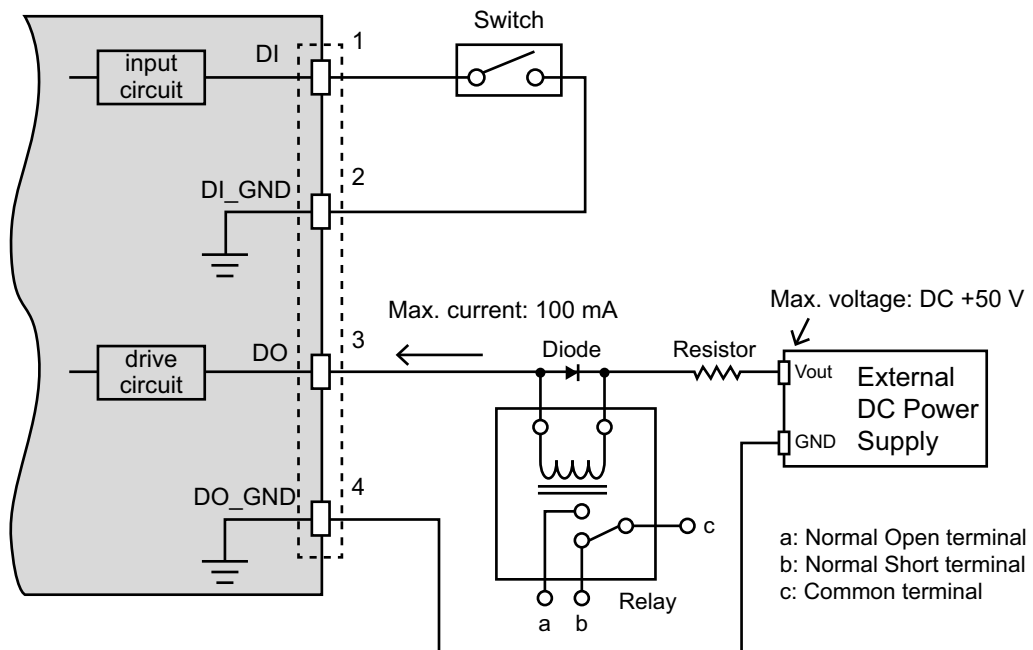

Note

- In case of door opener drive by digital output, three-terminal type external relays are recommended. Regarding external relays, there is also a two-terminal type that is "Normally Open" and "Normally

Short". If two-terminal types are used, there is a risk that the door opener cannot be driven correctly, due to mismatch with the door opener and relay specifications.

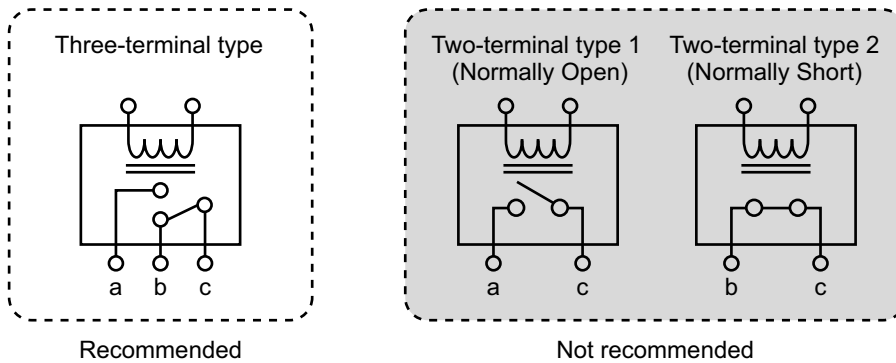

Connect a digital input/output device to the I/O pins of KX-NTV150/KX-NTV160. From the Applications → DI and DO page, you can let the KX-NTV150/KX-NTV160 report the current signal status. See page 119.

1.6.4 Hardware Reset

Press the buttons according to the model to reset the KX-NTV150/KX-NTV160:
 KX-NTV150: Press WPS/Reset button (①) for over 30 seconds.

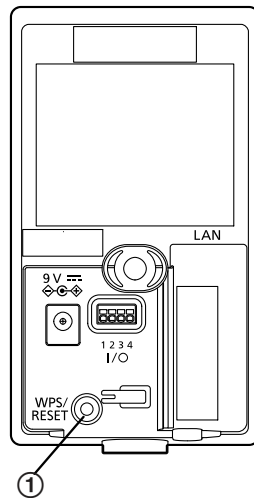

KX-NTV160: Press Reset button (①) inside the screw cover for over 30 seconds.

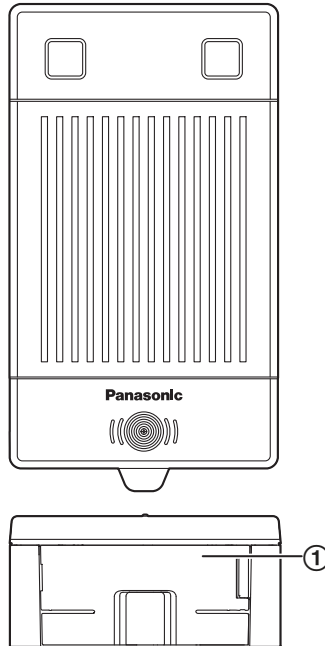

The reset button is used to restore the factory default settings. Sometimes resetting the system can return KX-NTV150/KX-NTV160 to normal operations. If the system problems remain after reset, restore the factory settings and install again. Press and hold the reset button until the status LED rapidly blinks with Green 0.25 second On/0.25 second off status. Upon successful restore, KX-NTV150/KX-NTV160 will reboot and all settings will restore to factory default.

1.6.5 Network Deployment

KX-NTV150 (Communication IP Camera)

When using a non-PoE switch

1. Connect the camera to a switch via an Ethernet cable or directly to a computer. The Ethernet cable must be connected before turning on the power.

2. Connect the supplied power cable from the camera to a power outlet.

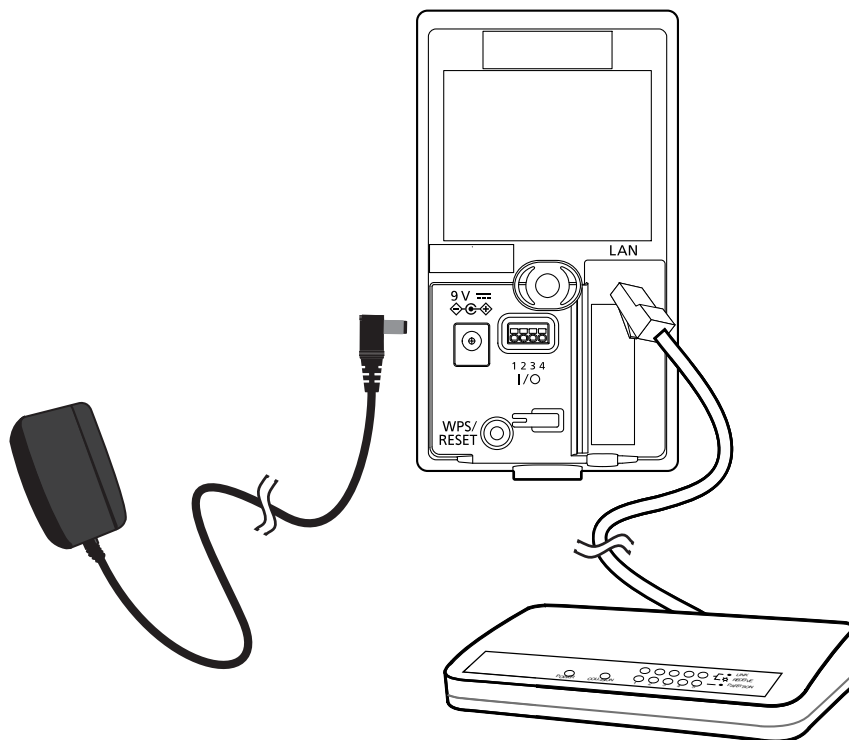
**Note**

- Because the KX-NTV150 can enter wireless mode or LAN mode, if you want to enter LAN mode, please only use a PoE cable, or insert an AC adaptor and LAN cable at the same time within 35 seconds. If you want to enter wireless mode, please only insert an AC adaptor and boot up.
- This equipment is only to be connected to PoE networks without routing to outside plants.

When using a PoE-enabled switch

KX-NTV150 is PoE-compliant, allowing transmission of power and data via a single Ethernet cable. Follow the below illustration to connect the KX-NTV150 to a PoE-enabled switch via an Ethernet cable.

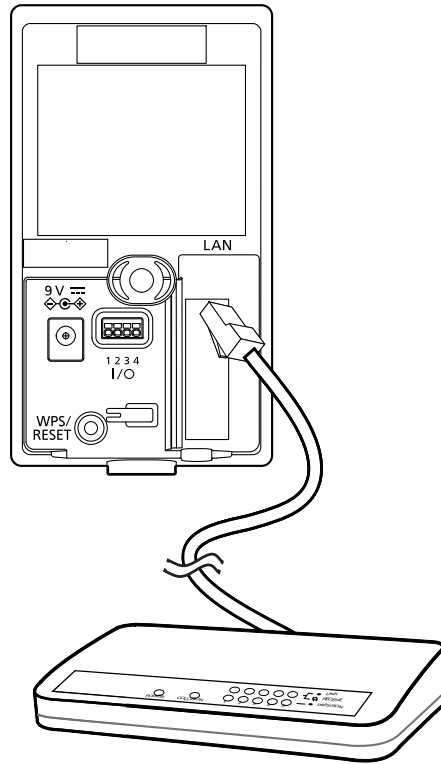

KX-NTV160 (IP Video Doorphone)

When using a PoE-enabled switch

1. The KX-NTV160 is PoE-compliant, allowing transmission of power and data via a single Ethernet cable. Follow the below illustration to connect the KX-NTV160 to a PoE-enabled switch via an Ethernet cable.

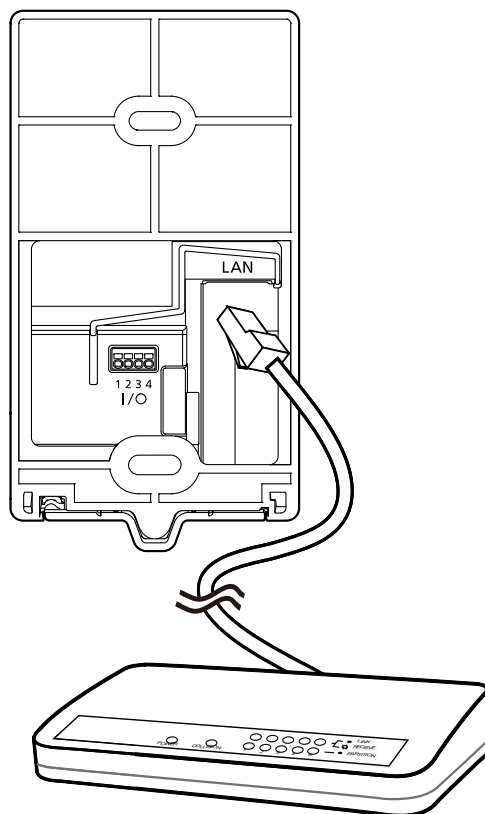

Internet connection via a router

Before setting up the KX-NTV150/KX-NTV160 over the Internet, make sure you have a router and follow the steps below.

1. Connect your KX-NTV150/KX-NTV160 behind a router (the Internet environment is illustrated below). Regarding how to obtain an IP address, please refer to Software Installation on page 35 for details.

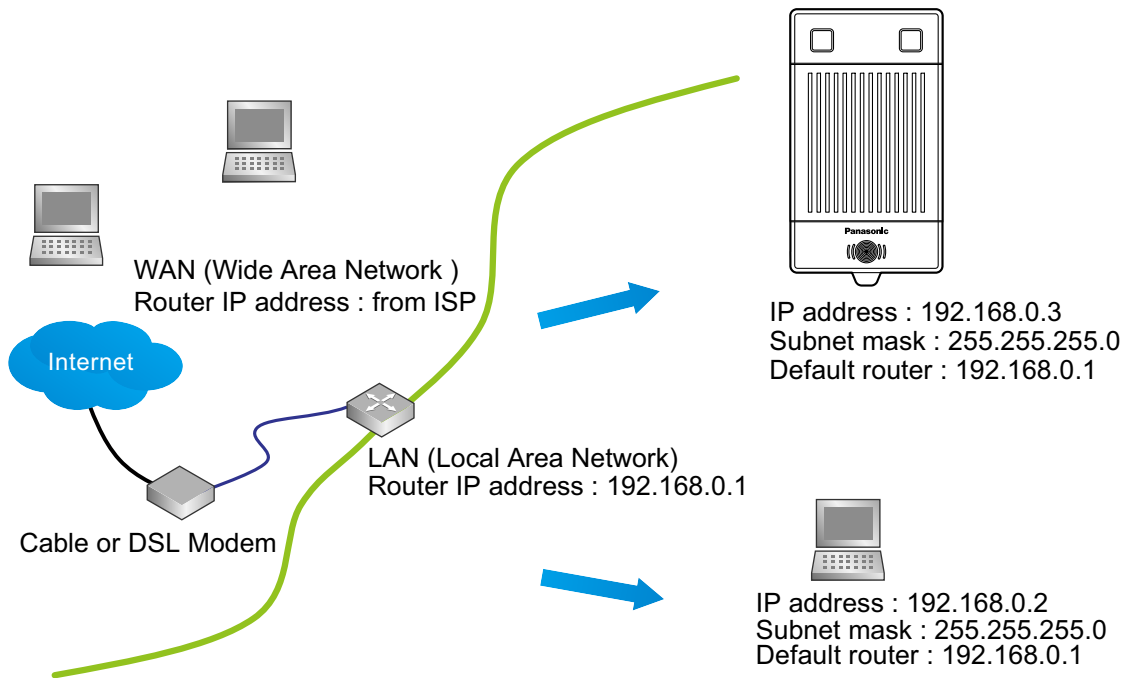

2. In this case, if the Local Area Network (LAN) IP address of your KX-NTV150/KX-NTV160 is 192.168.0.3, please forward the following ports for the KX-NTV150/KX-NTV160 on the router.
 - HTTP port: default is 80; secondary HTTP port is 8080
 - RTP port for audio: default is 5558
 - RTCP port for audio: default is 5559
 - RTP port for video: default is 5556
 - RTCP port for video: default is 5557

If you have changed the port numbers on the Network page, please open the ports accordingly on your router. For information on how to forward ports on the router, please refer to your router's user's manual.
3. Find out the public IP address of your router provided by your ISP (Internet Service Provider). Use the public IP and the secondary HTTP port to access KX-NTV150/KX-NTV160 from the Internet. Please refer to Network type on page 78 for details.

For example, your router and IP settings may look like this:

Device	IP address: internal port	IP address: external port (mapped port on the router)
Public IP of router	122.146.57.120	
LAN IP of router	192.168.2.1	
Camera 1	192.168.2.10: 80	122.146.57.120: 8000
Camera 2	192.168.2.11: 80	122.146.57.120: 8001
...

Configure the router, virtual server or firewall, so that the router can forward any data coming into a preconfigured port number to KX-NTV150/KX-NTV160 on the private network, and allow data from the camera to be transmitted to the outside of the network over the same path.

From	Forward to
122.146.57.120: 8000	192.168.2.10: 80
122.146.57.120: 8001	192.168.2.11: 80
...	...

When properly configured, you can access KX-NTV150/KX-NTV160 behind the router using the HTTP request as follows: `http://122.146.57.120: 8000`

If you change the port numbers on the Network configuration page, please open the ports accordingly on your router. For example, you can open a management session with your router to configure access through the router to KX-NTV150/KX-NTV160 within your local network. Please consult your network administrator for router configuration if you have troubles with the configuration.

For more information with network configuration options (such as that of streaming ports), please refer to Configuration → Network. The KX-NTV150/KX-NTV160 also provides the automatic port forwarding feature as an NAT traversal function with the precondition that your router must support the UPnP™ port forwarding feature.

The screenshot shows the 'Network type' configuration page with the 'Port' tab active. The 'LAN' section is selected, and 'Use fixed IP address' is chosen. The IP address is set to 192.168.6.215, the subnet mask to 255.255.255.0, and the default gateway to 192.168.6.1. A blue notification box is overlaid on the form, stating: "The device is configuring now. Your browser will reconnect to `http://192.168.6.215:80/`. If the connection fails, please manually enter the above IP address in your browser." A 'Save' button is located at the bottom right of the configuration area.

Internet connection with static IP

Choose this connection type if you are required to use a static IP for the KX-NTV150/KX-NTV160. Please refer to LAN setting on page 78 for details.

1.6.6 Registering to a PBX

For information about how to register to a SIP PBX, please refer to page 64 SIP setting.

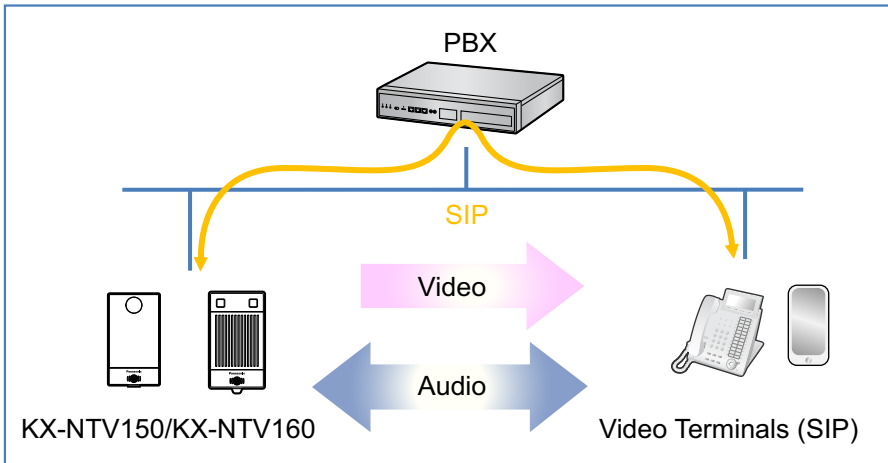

Note

- Images can only be sent through IP networks. Images cannot be sent if analog cables are used.
- The KX-NTV150/KX-NTV160 can only be used with following models.
(The KX-NTV150/KX-NTV160 cannot be used with third-party PBXs, SIP servers or other Panasonic PBXs such as KX-NCP PBXs.)

Model	Activation Key Requirement
KX-NS Series	An IP-Extension Activation Key for KX-NT series is required
KX-NSX Series	A Panasonic Peripheral Device Activation Key is required

For more details, please see the product specifications of each PBX.

1.7 LED Status

Feature		KX-NTV150	KX-NTV160
Status 1	Light out	Power off, Force to light out by WEB access menu	
Status 2	Blinking Orange 0.5 second On/ 0.5 second off	Network connected (wired or wireless)	
Status 3	Steady Green	SIP registered (wired or wireless)	
Status 4	Blinking Red 0.25 second On/ 0.25 second off	Searching for WPS	—
Status 5	Blinking Blue 0.25 second On/ 0.25 second off	Call button pushed (communication not yet)	
Status 6	Steady Blue	During communication	
Status 7	Blinking Green (0.5 second On) and Red (0.5 second On)	Upgrading firmware	

Feature		KX-NTV150	KX-NTV160
Status 8	Blinking Green 0.25 second On/ 0.25 second off	Restoring default	
Status 9	Steady Red	During system boot, No network connection	

Note

- If the LED is blue for a short time during boot up, this means that the system is starting boot up.

1.8 Hardware Key

Feature		KX-NTV150	KX-NTV160
WPS/RESET Button	Wireless network connect by WPS	Push button more than 2 seconds	–
	System reset (Factory default)	Push button more than 30 seconds. Also reset executable by configuration menu on WEB access	Push button more than 30 seconds. Also reset executable by configuration menu on WEB access
Call Button	Communication call	Outgoing call Call cancel	Outgoing call

1.9 Communication IP Camera Call (KX-NTV150)

Using SIP Outgoing Call function, bidirectional voice communication and 1 way (Communication IP Camera → other PBX terminal) video communications are executed between the Communication IP Camera and the other PBX terminal.

1. Make a call

- There are 2 ways to establish a voice communication with a Communication IP Camera.
 - Make a call from the Communication IP Camera to internal/external line.
 - Make a call from an internal line to the Communication IP Camera.

2. Make a call from the IP Camera

1. Pressing the call button (①) of Communication IP Camera to start a call.

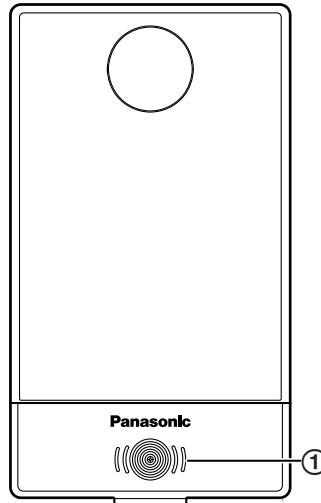

User can set a callee (Internal line number) from the KX-NTV150 Communication IP Camera with an embedded Web menu.

External line is selectable for callee too. We call this phone number a SIP outgoing number. Please refer to SIP outgoing setting on page 111.

2. If the Call button of the Communication IP Camera was pressed, key confirmation tone rings, and Status LED starts blinking (Blue 0.25 second on/0.25 second off). In addition, at the Communication IP Camera side a Ring-back Tone is audible.
3. If the callee answers the call, the callee can monitor the video from the Communication IP Camera (if callee is Video/Audio SIP client). However, the Communication IP Camera maintains the Communication IP Camera call status.
4. Pressing Dial key* starts the Communication IP Camera talking (if callee is Video/Audio SIP client). In this case, status LED turns Blue on.
5. It is possible to skip video monitor and immediately start the Communication IP Camera talking with the embedded web menu, please refer to page 63.
6. If the callee is an Audio SIP client, the Communication IP Camera talking starts by answering the Communication IP Camera call without pressing Dial key*.
7. If the callee does not answer within the Communication IP Camera Call ring duration (default 30 seconds), the IP Camera call stops, and the status LED turns on Green.
8. If the callee does not answer within the time of the Communication IP Camera Call ring duration (Default: 30 seconds), the Communication IP Camera call stops and the video monitor stops. The Status LED turns on Green.
9. If the callee does not press Dial key* but just ends the incoming call, the video monitoring finishes. However, the Communication IP Camera call continues until the call ring duration has elapsed.
10. From the embedded web menu, you can configure the Communication IP Camera call to end immediately or to continue calling. Please refer to page 63.
11. If call button was pressed during the call ring duration, the SIP outgoing call stops.
12. The Communication IP Camera answers busy when an internal line makes a call during the call ring duration.
13. If the callee is busy (or cannot answer), a busy tone rings. The PBX rejects the connection and does not connect. The status LED keeps blinking (Blue 0.25 second on/0.25 second off). Then the Communication IP Camera stops calling after ringing a busy tone for 10 seconds. The busy tone stops immediately when the call button is pressed during ringing busy tone.
14. After pressing the call button and during calls, operations are ignored if users press a call button within a second. After a second passes from pressing the call button, if the user presses a call button again, it sounds the Key confirmation tone and goes back to the idle status. The video will be stopped and the status LED turns on green.

The same applies for after pressing Dial Key*. If a user presses the call button again, it sounds the Key confirmation tone and goes back to idle status. The video will be stopped and the status LED turns on green.

15. Outgoing call triggered by an event

- The following events can trigger an outgoing call. Users can turn on/off each event with the embedded web menu.
 - "Video motion detection"
 - "Periodically"
 - "Digital input"
 - "System boot"
 - "Recording notify"
 - "Voice detection"
 - "Camera tampering detection"
 - "Manual triggers"
- SIP outgoing action is ignored during Communication IP Camera call or Communication IP Camera talking.
- Other operations are the same as triggered by pressing call button.

* Call ring duration is variable.

Call ring duration: 10 seconds-150 seconds

Default: 30 seconds

3. Make a call from Internal line

1. User can establish a call with Communication IP Camera by dialing internal line number assigned to Communication IP Camera.

* Internal line number for Communication IP Camera is changeable by embedded web menu. Please refer to page 61.

2. Communication IP Camera talking automatically begins by making a call from Internal line to Communication IP Camera. In this case, video monitor starts automatically too. Confirmation tones are sent to the IP Camera. Status LED will turn Blue on.
3. Indication of calling status (Ringing confirmation tone and turning Blue LED on) can be configurable by embedded web menu. Default values are "No Confirmation Tone when talking starts", "LED is steady Green", "When ending the talking, user does NOT hear the Reorder tone". About the setting, please refer to page 63.
4. Users cannot make a call to the Communication IP Camera that is OUS (Out Of Service). In this case, an internal line Reorder Tone is heard depending on the PBX used.
5. If the Communication IP Camera is called by another extension while the Communication IP Camera is talking, the Communication IP Camera is busy (SIP multi session is not supported).
6. If the user presses a call button again while the Communication IP Camera is calling, the call ends. The video will be stopped and the status LED turn on green.

4. Communication IP Camera talking with optional door opener control

1. The callee can operate a door opener after answering the Communication IP Camera call or Communication talking (refer to connection with Digital output and external relay on page 18). External relay is turned on by Digital output. The "Make time" means turn on time that can be modified with the Embedded Web menu. Please refer to Digital output on page 119.

2. Camera control (ePTZ) is available after answering a call and during talking. ePTZ can be controlled by exclusive software or Dial Key detection. Please see the figure below. It shows the operation and Dial Key number.

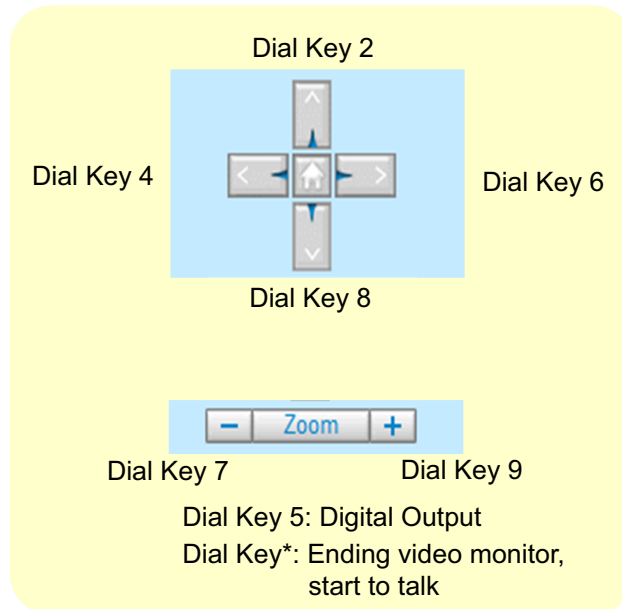

* Door locking depends on the door opener (Digital output) specifications. The Communication IP Camera cannot lock the door.

Once camera receiving Dial Key, after door opening, conversation will be ended after 8 seconds. Once receiving Dial Key, camera will not receiving Dial Key until next conversation.

3. The Communication IP Camera talking ends in following cases. If talking ends, the video monitoring ends too. The status LED turns on green.

1. Callee finishes talking with the Communication IP Camera. Talking ends after ringing re-order tone for 3 seconds after the callee ends talking.

Note

- This behavior depends on embedded web menu settings.

2. Limit of conversation time elapsed from starting the Communication IP Camera call. Talking ends after ringing re-order tone for 3 seconds.
3. Pressing the Call button again while talking can end the Communication IP Camera talking.

5. Control Embedded web menu

Users can operate the door opener (Digital output) from "Home" – "View" of the Embedded web menu.

Note

- Operations can be made even when not talking.

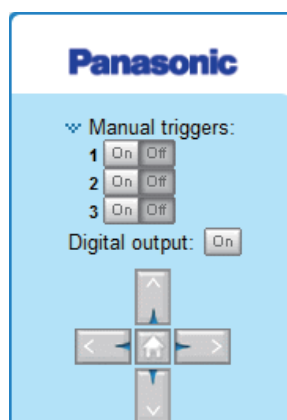

1.10 IP Video Doorphone Call (KX-NTV160)

Using the SIP Outgoing Call function, bidirectional voice communications and 1 way (IP Video Doorphone → other PBX terminal) video communications are executed between IP Video Doorphones and other PBX terminals.

Note

- IP Video Doorphone is registered as a SIP extension.
1. Make a call
 - There are 2 ways to establish a voice communication with an IP Video Doorphone.
 - a. Make a call from the IP Video Doorphone to the internal/external line.
 - b. Make a call from an internal line to the IP Video Doorphone.
 2. Make a call from doorphone
 1. Pressing the call button (①) of the IP Video Doorphone to start a call.

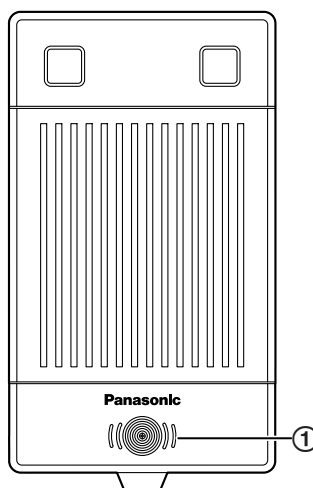

Users can set a callee (internal line number) from the doorphone with the embedded Web menu. External lines are selectable for callees too. We call this phone number a SIP outgoing number. Please refer to page 61.

2. If a call button is pressed, Pinpon tone rings and the light source LED lights up according to the web setting, and the status LED starts blinking (Blue 0.25 second on/0.25 second off). In addition, at the IP Video Doorphone side ring-back tone is audible. (We call this status a Doorphone call).
3. If the callee answers a call, the callee can monitor the video from the IP Video Doorphone (if the callee is a Video SIP client).
4. Pressing Dial key* on the callee side starts IP Video Doorphone talking (if the callee is a SIP client that has both video and audio). In this case, the status LED will be on blue.
5. It is possible to change settings to skip video monitor and immediately to start doorphone talking with the embedded web menu. Please refer to page 63.
6. If the callee is an Audio SIP client, the IP Video Doorphone talking starts by answering the doorphone call without pressing Dial key*.
7. If the callee does not answer within the IP Video Doorphone Call ring duration (default: 30 seconds), the IP Video Doorphone call stops and the light source LED turns off. The status LED turns on green.
8. If the callee client do not press Dial key* within the Call ring duration (default: 30 seconds), the IP Video Doorphone call stops, video monitoring ends, the light source LED turns off and the status LED turns on green.
9. If the callee does not press Dial Key* but just hooks on, the Video monitoring finishes. However, the IP Video Doorphone call continues until the Call ring duration elapses.
10. From the embedded web menu, you can configure the Communication IP Camera call to end immediately or to continue calling. Please refer to page 63.
11. If call button was pressed during Call ring duration, Pinpon tone rings again, Ring back tone restarts and the Call ring duration timer is reset.
12. Doorphone answers busy when the Internal line makes a call during the Call ring duration.
13. If the callee is busy (or cannot answer), a busy tone rings and the status LED keeps blinking (blue 0.25 second on/0.25 second off). PBX rejects the call and does not connect. The doorphone stops calling after ringing a busy tone for 10 seconds. The busy tone stops immediately when a call button is pressed during a ringing busy tone.
14. After pressing a call button again during an internal call, call button operations within a second in length are ignored. After passing a second from pressing the call button, if a user presses the call button again, it sounds the Pinpon tone and restarts the Ring back tone. Next the calling timer for Call ring duration is extended (the duration is from when last pressing the call button). The same operation will be operated when the called unit is busy.
15. Outgoing call triggered by an event
 - The following events can trigger outgoing calls. Turn on/off each event with the embedded web menu.
 - "Video motion detection"
 - "Periodically"
 - "Digital input"
 - "System boot"
 - "Recording notify"
 - "Voice detection"
 - "Camera tampering detection"
 - "Manual triggers"
 - Events are ignored during IP Video Doorphone calls or IP Video Doorphone talking.
 - Other operations is the same as triggered by pressing call button.

* Call ring duration is variable.

Call ring duration: 10 seconds-150 seconds

Default: 30 seconds

3. Make a call from Internal line

1. Users can establish a call with the IP Video Doorphone by dialing internal line numbers assigned to the IP Video Doorphone.

* Internal line numbers for the IP Video Doorphone can be changed with the embedded web menu. Please refer to page 61.

2. IP Video Doorphone talking automatically begins by making a call from the Internal line to the IP Video Doorphone. In this case, video monitoring starts automatically too. Light source LED turns on (depending on embedded web menu settings). Confirmation tone is sent to the doorphone.
 3. Indication of calling status (Ringing confirmation tone and turning the blue LED on), can be configured with the embedded web menu. Default values are "No Confirmation Tone when talking starts", "LED is steady Green", "When ending the talking, user does NOT hear the Reorder tone". Please note that the light source LED does not follow this setting. About the setting, please refer to page 63.
 4. Users can not make a call to the IP Video Doorphone that is OUS (Out Of Service). In this case, an internal line Reorder Tone is heard depending on the PBX used.
 5. If the IP Video Doorphone is called by another extension during Doorphone talking, the Doorphone will be busy (SIP multi session is not supported).
4. IP Video Doorphone talking with optional door opener control
1. The callee can operate a door opener after answering the IP Video Doorphone call or Communication talking (refer to connection with Digital output and external relay on page 18). External relay is turned on by Digital output. The "Make time" means turn on time that can be modified with the Embedded Web menu. Please refer to Digital output on page 119.
 2. Camera control (ePTZ) is available after answering by callee and during talking. ePTZ can be controlled by exclusive software or Dial Key detection. Please see the figure below which shows operations and the Dial Key number.

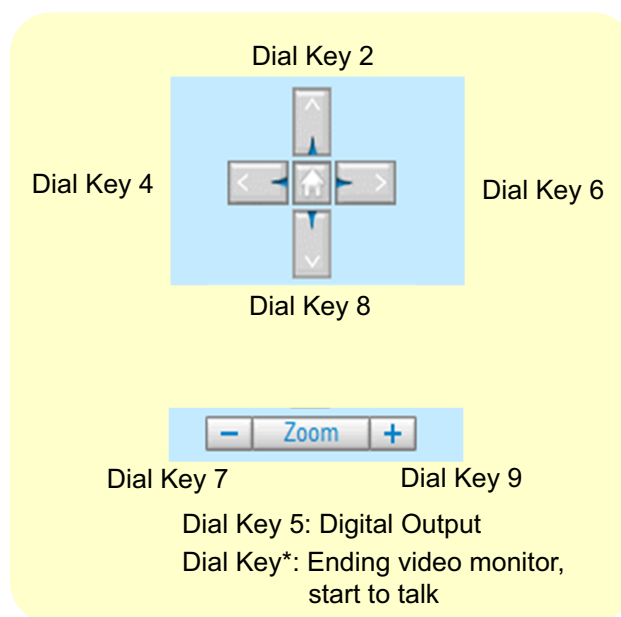

*Door locking depends on the door opener (Digital output) specifications.

IP Video Doorphone cannot lock the door.

Once the camera receives Dial Key 5 after opening the door, conversations will end after 8 seconds.

Once Dial Key 5 is received, the camera will not receive Dial Key 5 until the next conversation.

3. IP Video Doorphone talking ends in following cases.

If talking ended, video monitor ends too. Status LED turns on green, light source LED turns off depending on the embedded Web menu setting.

 1. Callee finishes Doorphone talking.

Talking ends after ringing re-order tone for 3 seconds after the callee ends talking.

* This behavior depends on the embedded web menu settings.
 2. Limit of conversation time has elapsed since starting the doorphone call.

Talking ends after ringing re-order tone for 3 seconds.
 3. The door opener (Digital output) is operated. Talking ends after hear a confirmation tone after 8 seconds.

*Pressing call button is ignored during Doorphone talking.

5. Control Embedded web menu

1. User can operate door-opener (Digital output) on "Home" - "View" of Embedded web menu.

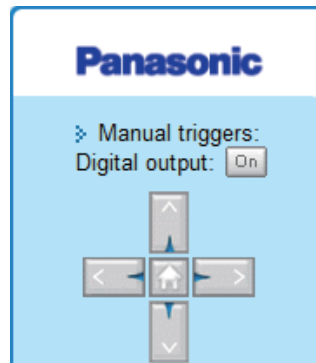

* Can be operated even when not talking with the doorphone.

2. Users can turn light source LED On/Off on "Home" - "View" of the embedded web menu. It depends on the Manual Emitting on the embedded web menu. Please refer to page 67.

*Can be operated even when not talking.

2 Software

2.1 Software Installation

Installation Wizard

Supported operating systems: Microsoft® Windows® 10/Windows 8/Windows 7 above

If the IP address of KX-NTV150/KX-NTV160 is unknown, Installation Wizard App can search the camera devices. By double clicking the model name, browser will be opened to camera live view and camera setting page.

For more detailed information about the Installation wizard, please refer to the Installation wizard manual.
<http://panasonic.net/pcc/support/pbx/>

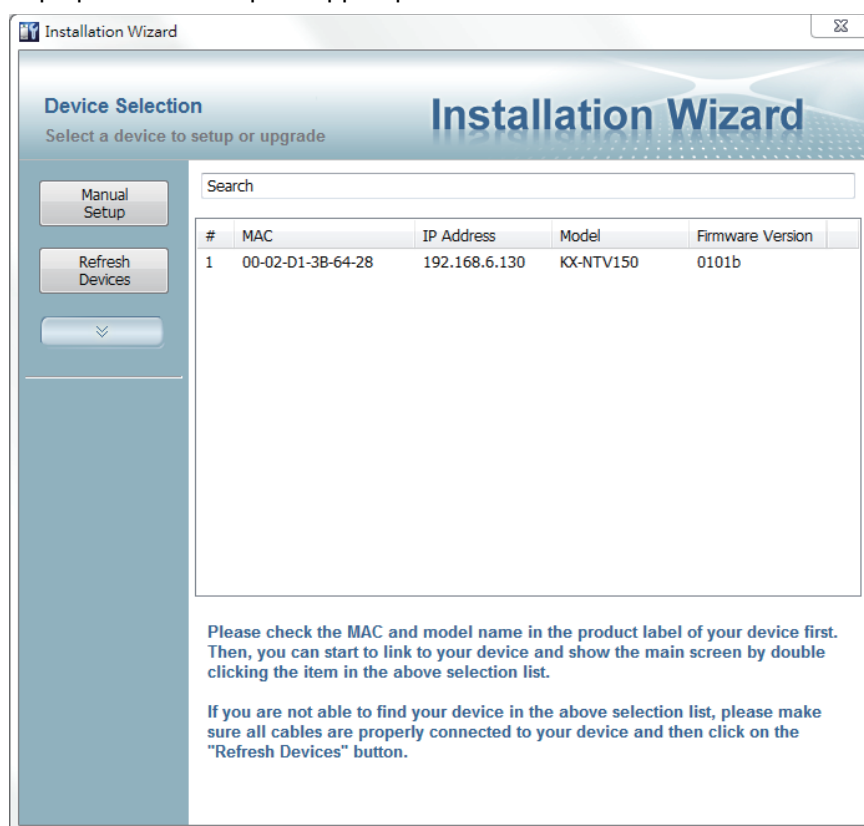

2.2 Accessing the KX-NTV150/KX-NTV160

This section explains how to access the KX-NTV150/KX-NTV160 through web browsers, and RTSP players.

Note

- If the KX-NTV150/KX-NTV160 is disconnected or the IP address does not exist anymore, because Installation Wizard cannot manually set IP addresses that do not exist, please refresh Installation Wizard again to get the correct IP address, and then try manually configuring again.

Using Web Browsers

Use the Installation Wizard to access the KX-NTV150/KX-NTV160 on the LAN:

2 Software

1. Launch your web browser (e.g., Microsoft Internet Explorer® or Mozilla® Firefox®).
 - Some functions are restricted if Mozilla Firefox is used. (Restrictions include Client settings not being available, reduced number of available Home buttons, and delays in displaying images.)
2. Enter the IP address of the KX-NTV150/KX-NTV160 in the address field. Press Enter.
3. Login with the user name and password.
Default user name: admin
Default password: adminpass
4. The live video will be displayed in your web browser.
5. If it is the first time installing the KX-NTV150/KX-NTV160, an information bar asking you to install plug-in software will be displayed. In order to view images and videos, this plug-in software must be installed. Follow the instructions to install the required plug-in on your computer.

Note

- For Mozilla Firefox users, your browser will use QuickTime® to stream the live video. If you don't have QuickTime on your computer, please download it first, and then launch the web browser. We suggest to set all plugin functions with Internet Explorer, such as Motion detection, Privacy mask.
- QuickTime plugin operations may be affected by firewalls causing videos not to be played. If this happens, please contact your network administrator.

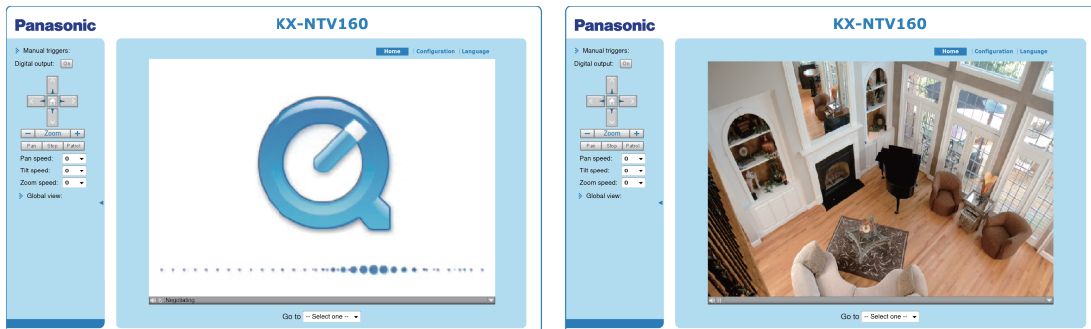

- To prevent unauthorized access, it is highly recommended to change the password for the KX-NTV150/KX-NTV160. For more information about how to enable password protection, please refer to Security on page 92.
- If you see a dialog box indicating that your security settings prohibit running ActiveX® Controls, please enable the ActiveX Controls for your browser.

1. Choose Tools → Internet Options → Security → Custom Level.

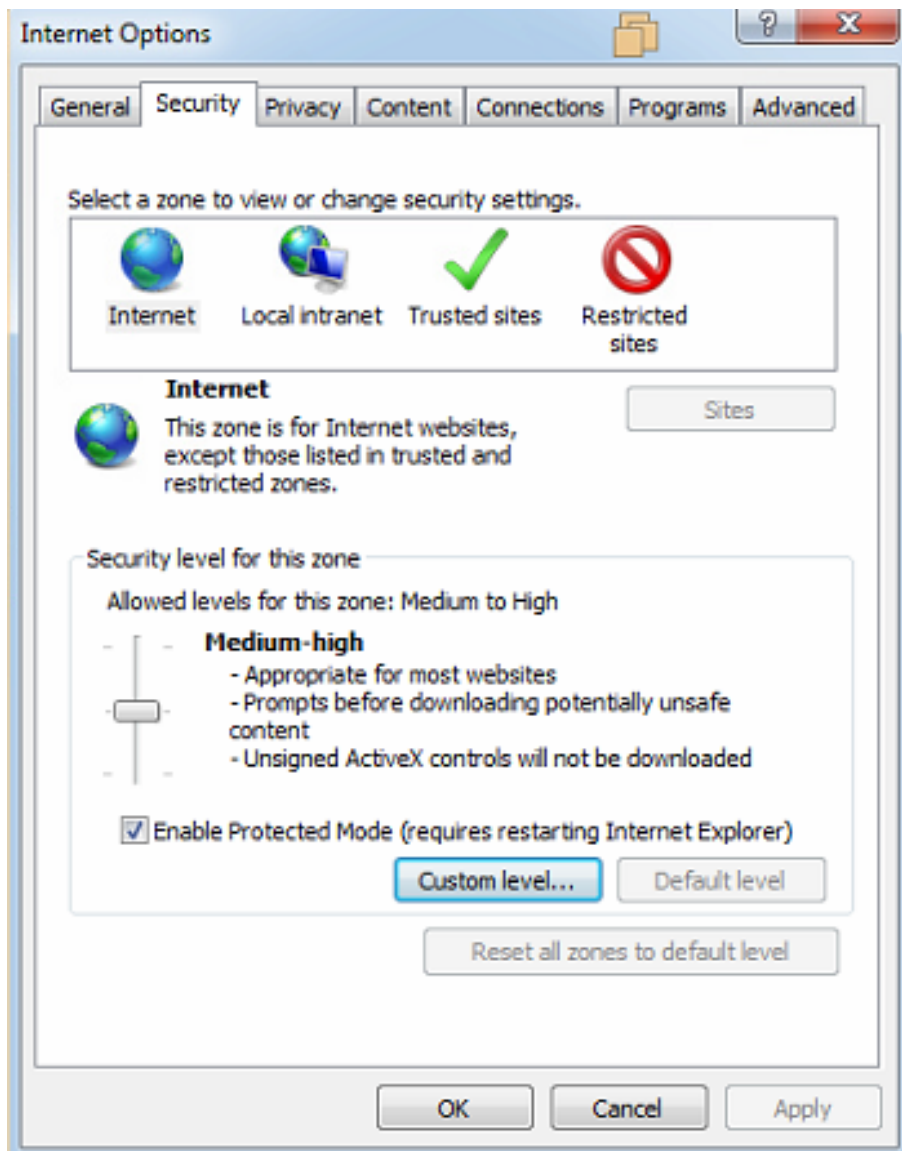

2. Look for Download signed ActiveX controls; select Enable or Prompt. Click OK.

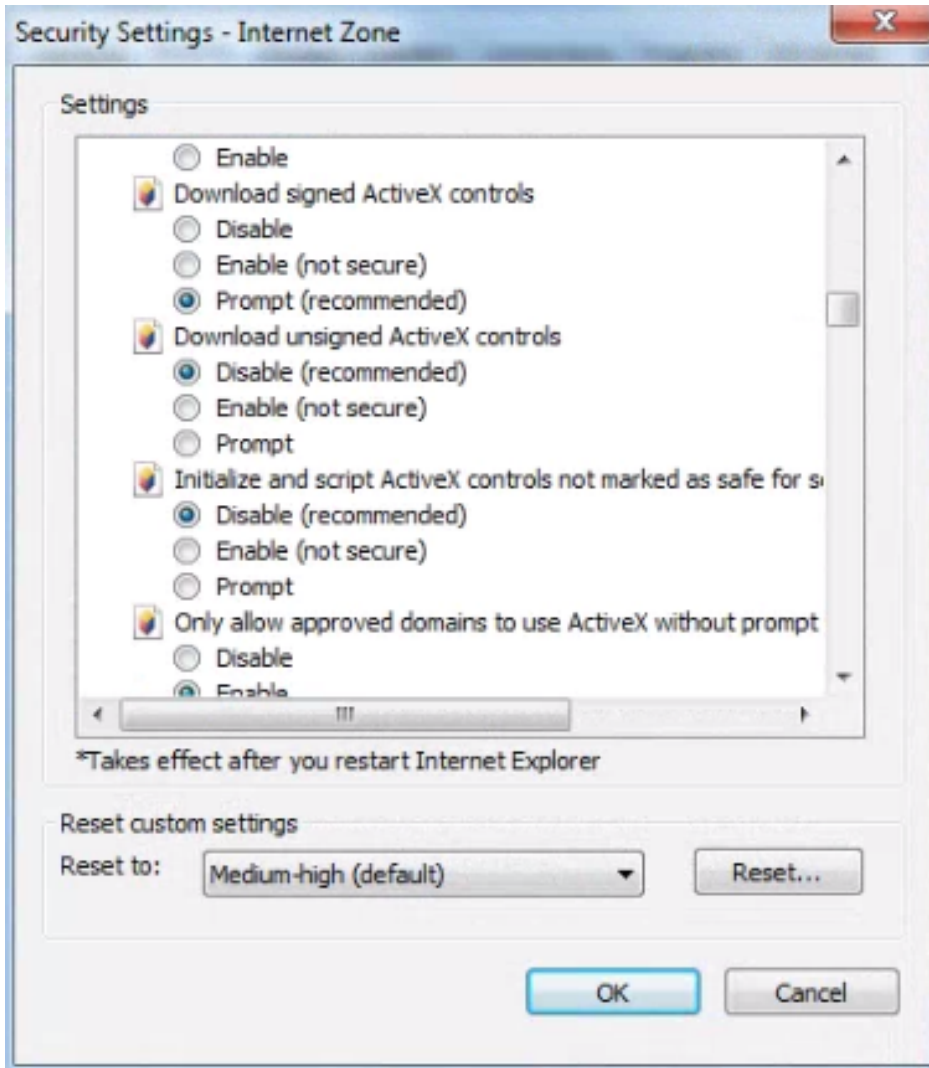

3. Refresh your web browser, and then install the ActiveX control. Follow the instructions to complete installation.

IMPORTANT

- Currently the KX-NTV150/KX-NTV160 utilizes 32-bit ActiveX plugin. You cannot open a management/view session with the KX-NTV150/KX-NTV160 using a 64-bit Internet Explorer browser.
- If you encounter this problem, try executing the iexplore.exe program from C:\Windows\SysWOW64. A 32-bit version of Internet Explorer browser will be installed.
- On Windows 7, the 32-bit explorer browser can be accessed from here: C:\Program Files (x86)\Internet Explorer\iexplore.exe



Hints:

The onscreen Java control can malfunction under the following situations:
A PC connects to different KX-NTV150/KX-NTV160 that are using the same IP address (or the same camera running different firmware versions). Removing your browser cookies will solve this problem.

Wireless Connection: Using the WPS Button (KX-NTV150 only)

1. Make sure your AP (Access Point) and Operating System support WPS (Wi-Fi Protected Setup) functions. WPS enables easy setup with compatible APs.
2. Disconnect your LAN cable, and connect the power cord.
3. Wait for the KX-NTV150 to boot up. Press the WPS button for more than 2 seconds. The front panel LED should blink red.
4. Press and hold down the WPS button on your AP (some routers/APs will have a virtual button in their management software instead). Refer to your AP's documentation for details on using its WPS functions.

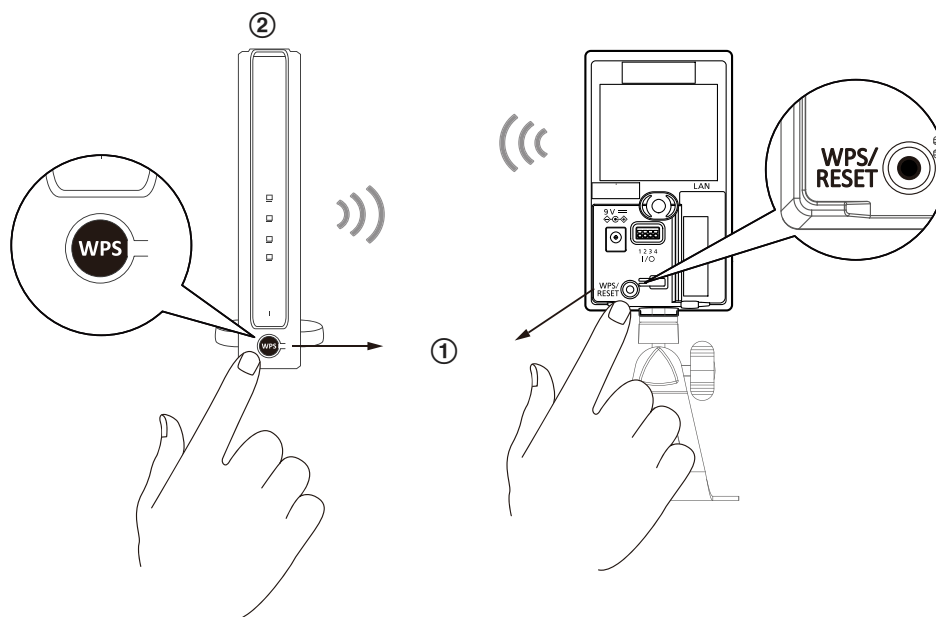

When WPS configuration is done, wireless connectivity will be established and the security encryption, such as WEP or WPA-PSK, will be synchronized with the AP. Use the IW utility to find the KX-NTV150. As for the IP setting, the KX-NTV150 use of DHCP or static IP is determined by your configuration on the KX-NTV150 via the web-based configuration of firmware. The KX-NTV150 default setting is DHCP.

Note

- It is strongly recommended to apply WPA2®/AES encryption for access security.
- WPS may not work if your AP is configured with a "hidden" SSID.
- If no WPS-enabled AP is detected, and if the KX-NTV150 still cannot detect an AP after 2 minutes, the wireless setup will be cancelled. If WPS configuration should fail, wireless configuration will be cleared. You can then re-try the process above or use a wired connection to establish a web console and manually configure the wireless settings.
- If a camera is assigned with a fixed IP outside the AP's network segment, wireless setup will fail.
- A wired connection always has a higher priority, and hence wireless setup will not take effect when the RJ45 LAN port is connected. If you want to switch from wired connection to wireless connection, disconnect the Ethernet cable and reboot the KX-NTV150.

Wireless Connection: Manual configuration

1. In addition to the use of WPS function, you can also use a wired connection to manually set up your wireless configuration.

2. Enter the Configuration → Wireless → WLAN page. Key in the same wireless settings as those on your router/AP (SSID, Wireless mode, Encryption type, and Pre-shared key).

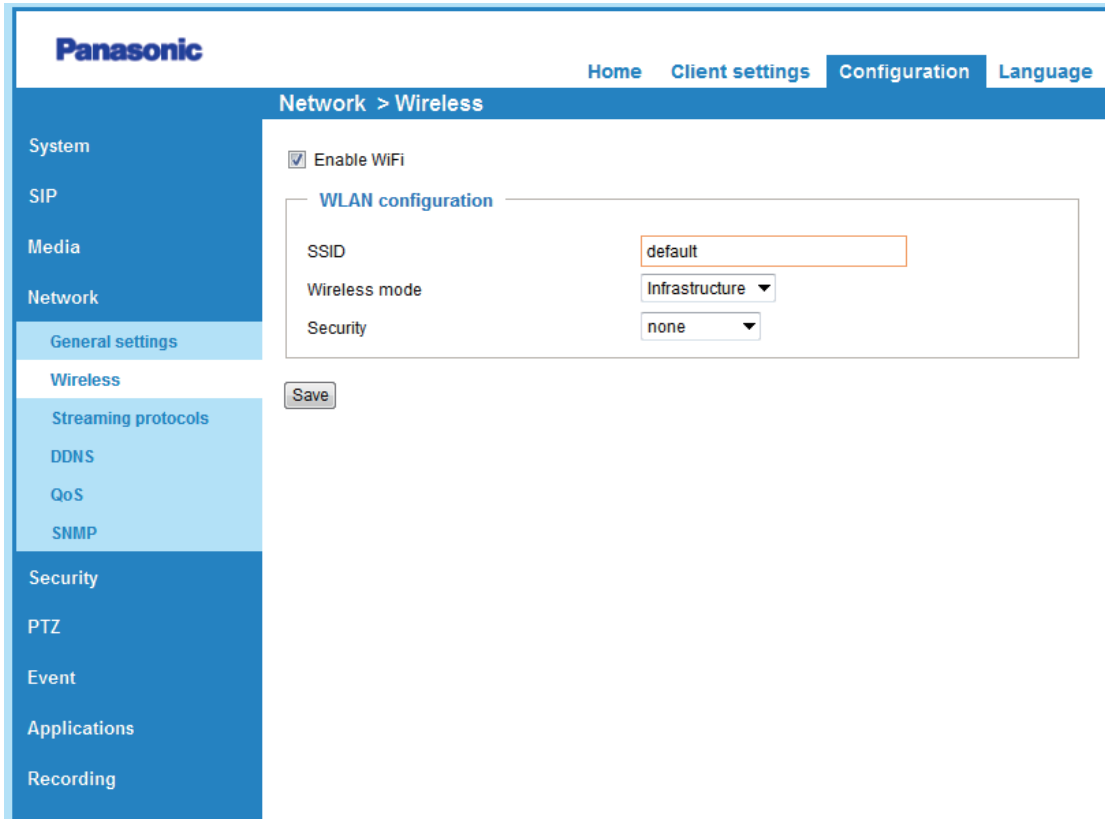

3. When done, click the Save button, disconnect the Ethernet cable and then reboot the KX-NTV150 (by disconnect and then connect the power cord). The KX-NTV150 should then be connected over the wireless network. If successfully configured, the KX-NTV150 LED should blink with Orange color every 0.5 seconds. If after booting up for 1 minute, the KX-NTV150 LED does not turn Green within 2 minutes, check your wireless configuration for errors.

2.3 Change the default password

When accessing the camera for the first time (the password is still in the default value) with a browser, after logging in with the default passwords for the root and admin accounts, the camera will ask you to change the default passwords to a different passwords in order to enhance security.

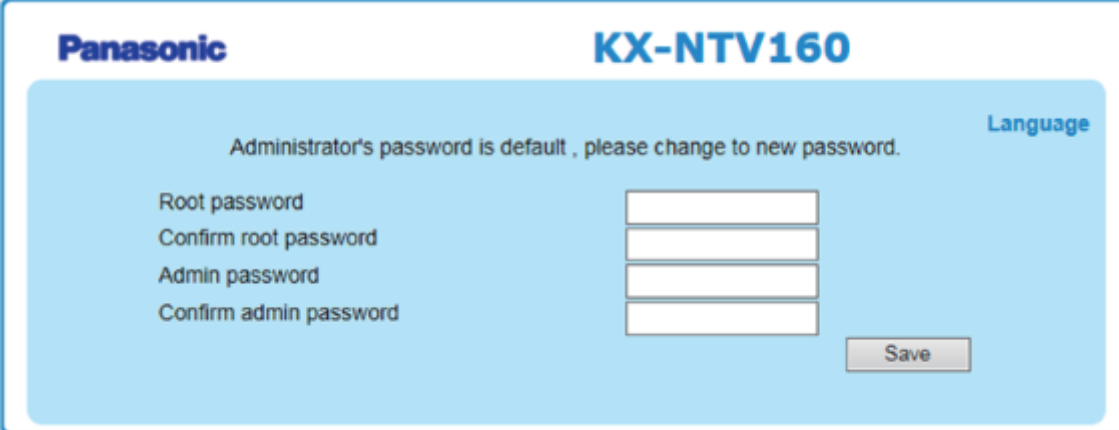

The screenshot shows the Panasonic KX-NTV160 web interface. At the top, the Panasonic logo and model number 'KX-NTV160' are displayed. Below this, a message states: 'Administrator's password is default , please change to new password.' To the right of this message is a 'Language' link. The main area contains four input fields: 'Root password', 'Confirm root password', 'Admin password', and 'Confirm admin password'. A 'Save' button is located at the bottom right of the form.

Please note the following when changing passwords:

1. Please enter the new password 2 times to ensure that there were no typing mistakes.
2. Please select a complicated password for your administrator account. The new password should be comprised of alphanumeric character and special characters (! \$ % - @ ^ _ ~). If the entered password is too simple, a message like the one below will be displayed.

When a simple password is set:

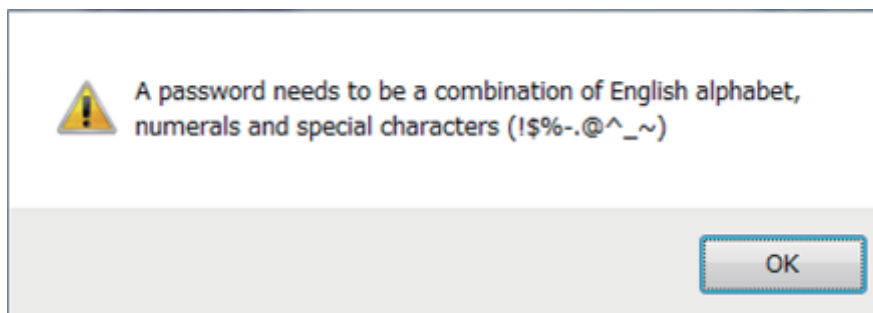

When a password with fewer than 8 characters was set:

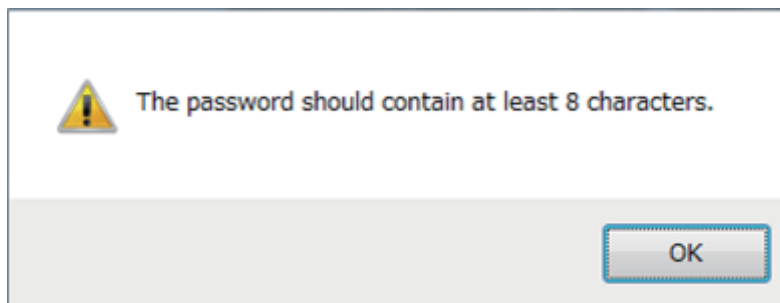

When not all passwords have been set:

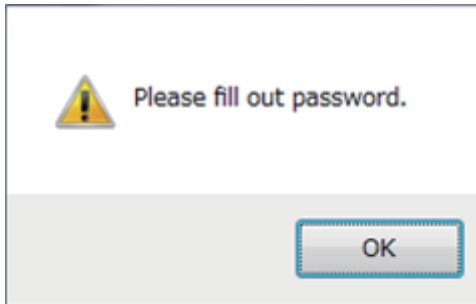

After successfully changing the default password, the camera will re-direct users to the Home view page.

2.4 Main Page

This section explains the layout of the main page. It is composed of the following parts: Panasonic Logo, Host Name, KX-NTV150/KX-NTV160 Control Area, Configuration Area, Menu, and Live Video Window.

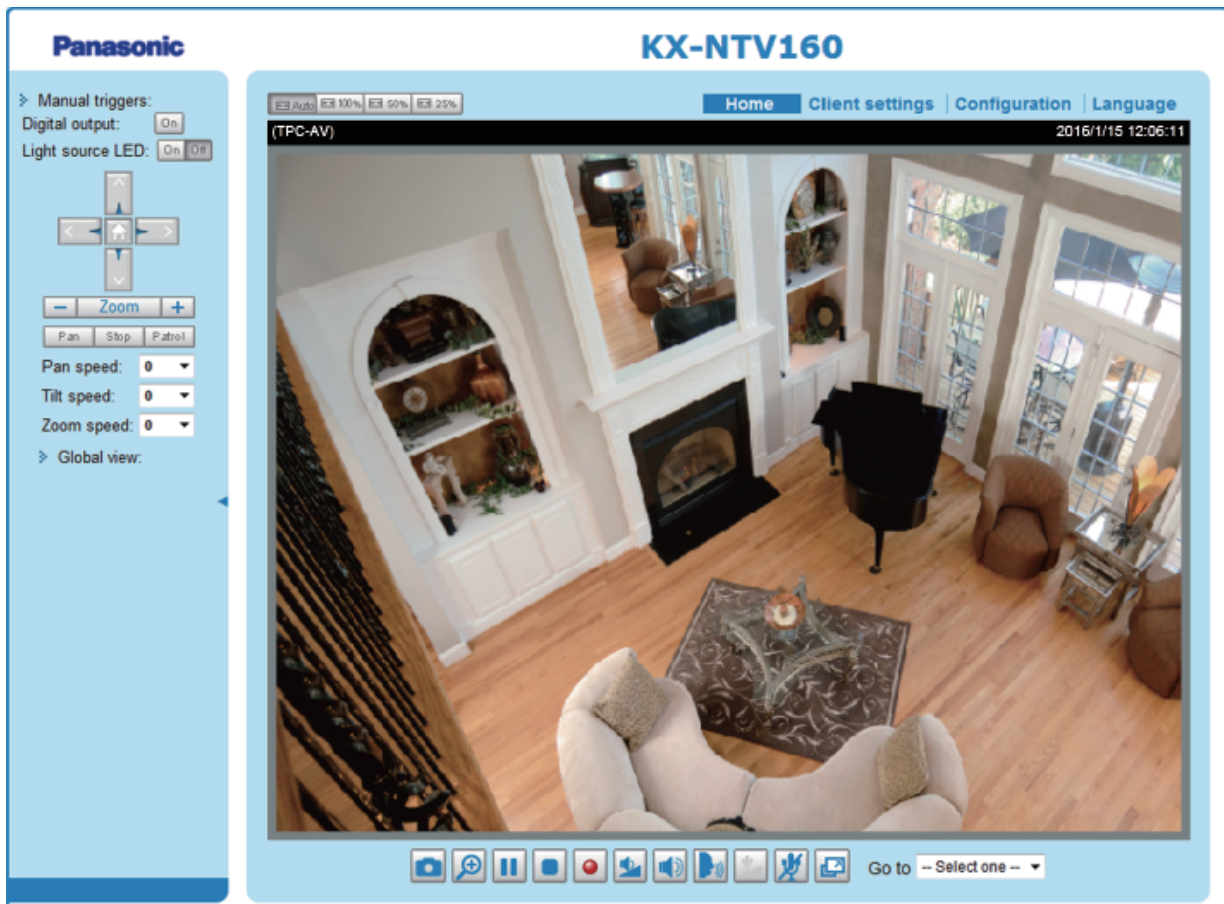

Host Name

The host name can be customized to fit your needs. For more information, please refer to System on page 49.

Manual triggers: Click to enable/disable an event trigger manually. Please configure an event setting on the Application page before enabling this function. A total of 3 event settings can be configured. For more

information about event settings, please refer to page 106. If you want to hide this item on the homepage, please go to Configuration → System → Homepage layout → General settings → Customized button to deselect "Show manual trigger button".

2.5 Configuration Area

Client settings: Click this button to access the client setting page. For more information, please refer to Client settings on page 47.

Configuration: Click this button to access the configuration page of the KX-NTV150/KX-NTV160. It is suggested that a password be applied to the KX-NTV150/KX-NTV160 so that only the administrator can configure the KX-NTV150/KX-NTV160. For more information, please refer to Configuration on page 49.

Language: Click this button to choose a language for the user interface. Language options are available in: English, Spanish, French, Italian, German, Portuguese, Russian, and Canadian French. Please note that you can also change the language on the Configuration page.

Hide Button

You can click the hide button to hide the control panel or display the control panel.

Resize Buttons



Click the Auto button, the video cell will resize automatically to fit the monitor.

Click 100% is to display the original homepage size.

Click 50% is to resize the homepage to 50% of its original size.

Click 25% is to resize the homepage to 25% of its original size.

Live Video Window

The following window is displayed when the video mode is set to H.264:

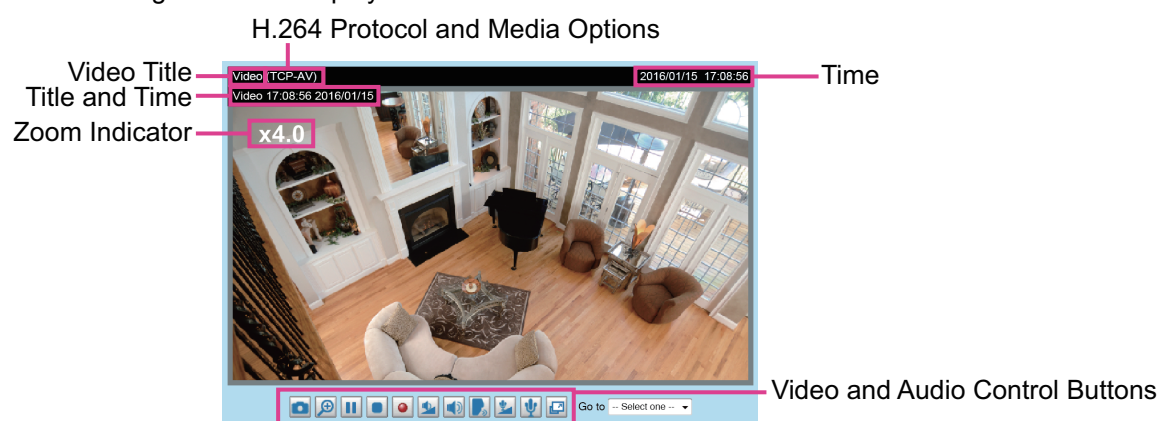

Video Title: The video title can be configured. For more information, please refer to Video Settings on page 65.

H.264 Protocol and Media Options: The transmission protocol and media options for H.264 video streaming. For further configuration, please refer to Client settings on page 49.

Time: Display the current time. For further configuration, please refer to Media → Image → General settings on page 65.

Title and Time: The video title and time can be stamped on the streaming video. For further configuration, please refer to Media → Image → General settings on page 65.

Global View: Click on this item to display the Global View window. The Global View window contains a full view image (the largest frame size of the captured video) and a floating frame (the viewing region of the current video stream). The floating frame allows users to control the e-PTZ function (Electronic Pan/Tilt/Zoom). For more information about e-PTZ operations, please refer to E-PTZ Operation on page 102. For more information about how to set up the viewing region of the current video stream, please refer to page 102.

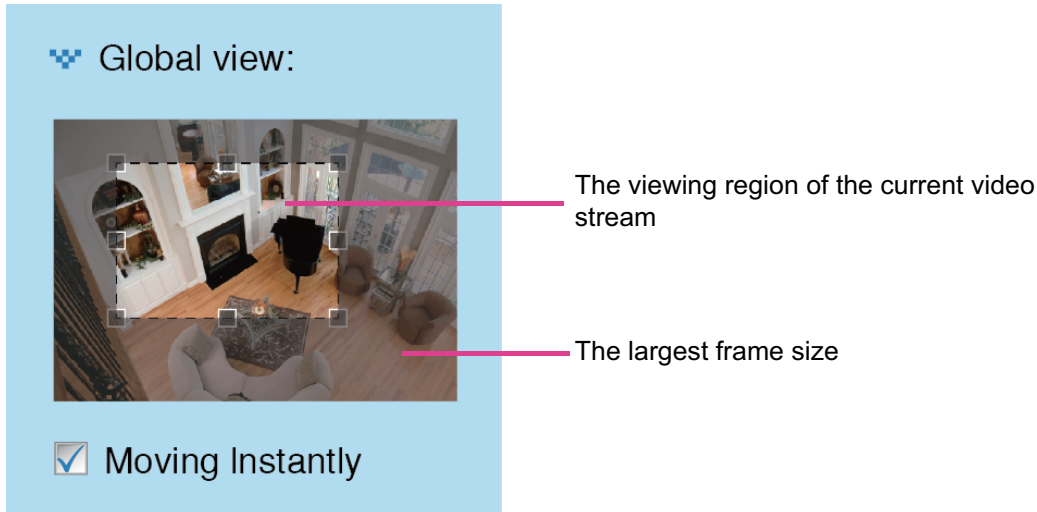

PTZ Panel: This KX-NTV150/KX-NTV160 supports both "digital" (e-PTZ) pan/tilt/zoom control. Please refer to PTZ settings on page 102 for detailed information. Note that the PTZ buttons on the panel are not operational unless you are showing only a portion of the full image. If the live view window is displaying the full view, the PTZ buttons are not functional.

Also, users can control settings through Dial Key by a SIP phone client as shown in the illustration below.

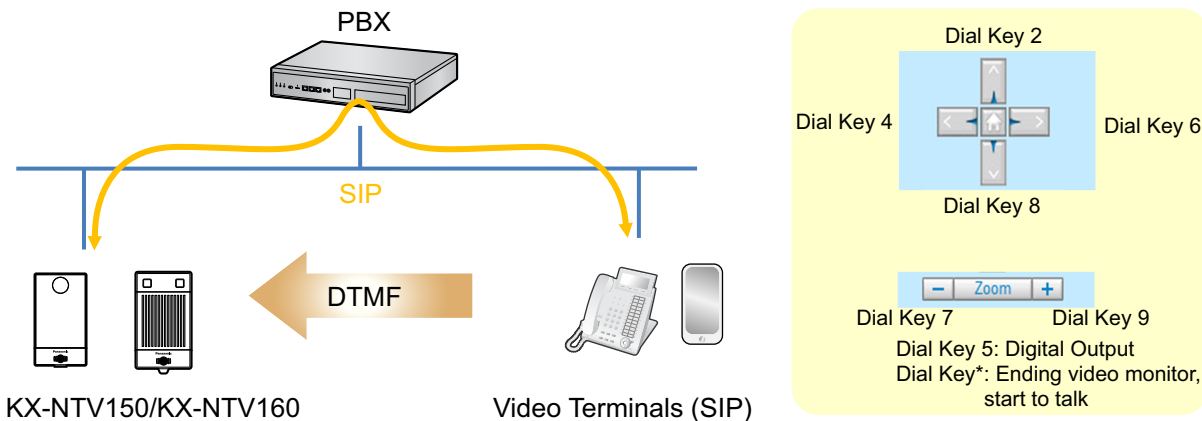



Light source LED: User can select Light source LED as ON/OFF from the home view. For information about how to enable the function in the home view, please refer to manual emit activate at page 67.

Snapshot: Click this button to capture and save still images. The captured images will be displayed in a pop-up window. Right-click the image and choose Save Picture As to save it in JPEG (*.jpg) or BMP (*.bmp) format.

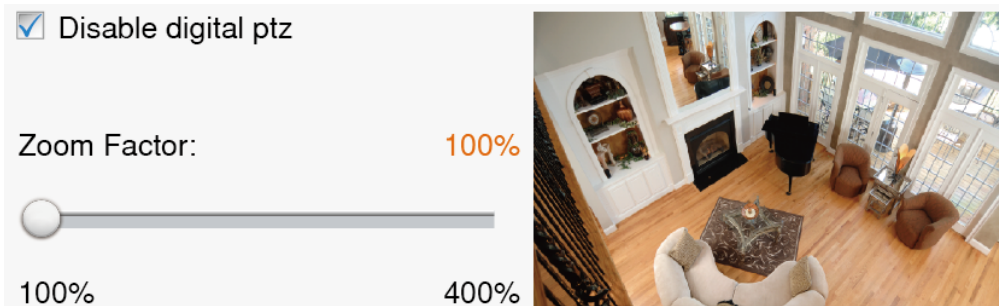

Digital Zoom: Click and uncheck "Disable digital zoom" to enable the zoom operation. The navigation screen indicates the part of the image being magnified. To control the zoom level, drag the slider bar. To move to a different area you want to magnify, drag the navigation screen.



Pause: Pause the transmission of the streaming media. The button becomes the  Resume button after clicking the Pause button.



Stop: Stop the transmission of the streaming media. Click the  Resume button to continue transmission.



Start MP4 Recording: Click this button to record video clips in MP4 file format to your computer. Press the  Stop MP4 Recording button to end recording. When you exit the web browser, video recording stops accordingly. To specify the storage destination and file name, please refer to MP4 saving options on page 48 for details.



Volume: When the  Mute function is not activated, move the slider bar to adjust the volume on the local computer.



Mute: Turn off the volume on the local computer. The button becomes the  Audio On button after clicking the Mute button.





Talk: Click this button to talk to people around the KX-NTV150/KX-NTV160. Audio will project from the external speaker connected to the KX-NTV150/KX-NTV160. Click this button  again to end talking transmission.



Mic Volume: When the  Mute function is not activated, move the slider bar to adjust the microphone volume on the local computer.



Mute: Turn off the  Mic volume on the local computer. The button becomes the  Mic On button after clicking the Mute button.



Full Screen: Click this button to switch to full screen mode. Press the "Esc" key to switch back to normal mode.

The following window is displayed when the video mode is set to MJPEG:

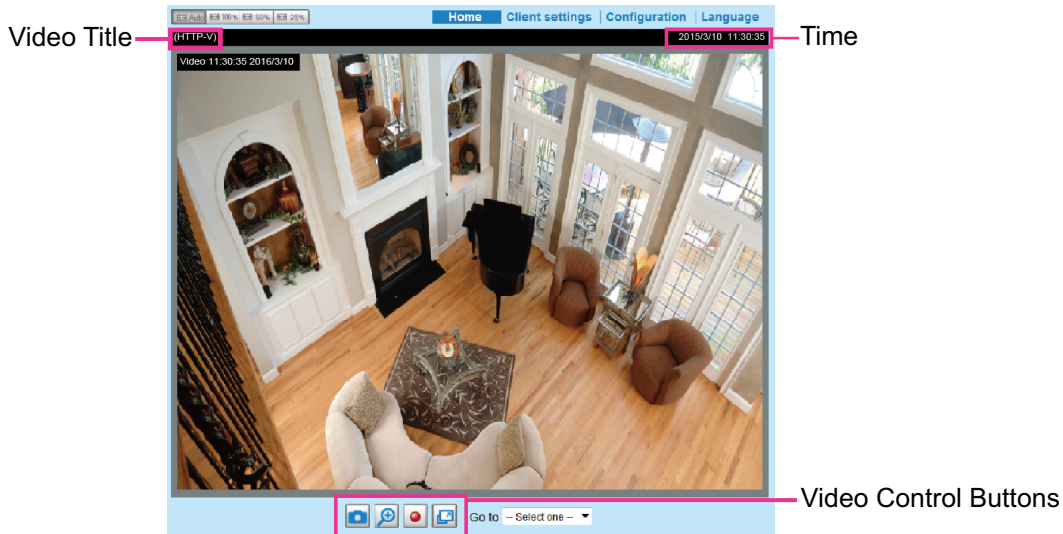

Video Title: The video title can be configured. For more information, please refer to Media → Image on page 65.

Time: Display the current time. For more information, please refer to Media → Image on page 65.

Title and Time: Video title and time can be stamped on the streaming video. For more information, please refer to Media → Image on page 65.

Video and Audio Control Buttons: Depending on the KX-NTV150/KX-NTV160 model and KX-NTV150/KX-NTV160 configuration, some buttons may not be available.



Snapshot: Click this button to capture and save still images. The captured images will be displayed in a pop-up window. Right-click the image and choose Save Picture As to save it in JPEG (*.jpg) or BMP (*.bmp) format.



Digital Zoom: Click and uncheck "Disable digital zoom" to enable the zoom operation. The navigation screen indicates the part of the image being magnified. To control the zoom level, drag the slider bar. To move to a different area you want to magnify, drag the navigation screen.

Disable digital ptz

Zoom Factor: 100%

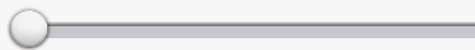

100% 400%



Start MP4 Recording: Click this button to record video clips in MP4 file format to your computer. Press



the **Stop MP4 Recording** button to end recording. When you exit the web browser, video recording stops accordingly. To specify the storage destination and file name, please refer to MP4 saving options on page 48 for details.



Full Screen: Click this button to switch to full screen mode. Press the "Esc" key to switch back to normal mode.

Go to

If you configured and chose to display a smaller region of interest from out of a maximum image frame, you can configure different areas within the frame as preset points, and use this menu to move to a location.



Client settings

This section explains how to select the stream transmission mode and saving options on the local computer. When completed with the settings on this page, click Save on the page bottom to enable the settings.

Note

- The Client page is not displayed in Mozilla browsers.

H.264 media options

H.264 media options

Video and audio
 Video only
 Audio only

Select to stream video or audio data or both. This is enabled only when the video mode is set to H.264.

H.264 protocol options

H.264 protocol options

UDP Unicast
 UDP Multicast
 TCP
 HTTP

Depending on your network environment, there are four transmission modes for H.264 streaming:

UDP Unicast: This protocol allows for more real-time audio and video streams. However, network packets may be lost due to network burst traffic and images may be broken. Activate UDP connection when occasions require time-sensitive responses and the video quality is less important. Note that each unicast client connecting to the server takes up additional bandwidth and the KX-NTV150/KX-NTV160 allows up to ten simultaneous accesses.

2.6 System

2.6.1 General settings

This section explains how to configure the basic settings for the KX-NTV150/KX-NTV160, such as the host name and system time. It is composed of the following two parts: System and System time. When finished with the settings on this page, click Save at the bottom of the page to enable the settings.

System

System

Host name:

Turn off the LED indicator

Host name: Enter a desired name for the KX-NTV150/KX-NTV160. The text will be displayed at the top of the main page.

Turn off the LED indicator: If you do not want others to notice the KX-NTV150/KX-NTV160 is in operation, you can select this option to turn off the LED indicators.

System time

System time

Time zone:

Enable daylight saving time

Note: You can upload your daylight saving time rules on [Maintenance](#) page or use the camera default value.

Keep current date and time
 Synchronize with computer time
 Manual
 Automatic

NTP server:

Updating interval:

Keep current date and time: Select this option to preserve the current date and time of the KX-NTV150/KX-NTV160. The KX-NTV150/KX-NTV160 internal real-time clock maintains the date and time even when the power of the system is turned off.

Synchronize with computer time: Select this option to synchronize the date and time of the KX-NTV150/KX-NTV160 with the local computer. The read-only date and time of the PC is displayed as updated.

Manual: The administrator can enter the date and time manually. Note that the date and time format are [yyyy/mm/dd] and [hh:mm:ss].

Automatic: The Network Time Protocol is a protocol which synchronizes computer clocks by periodically querying an NTP Server.

NTP server: Assign the IP address or domain name of the time-server. Leaving the text box blank connects the KX-NTV150/KX-NTV160 to the default time servers.

Updating interval: Select to update the time using the NTP server on an hourly, daily, weekly, or monthly basis. Input 60 for hourly updates, 86,400 for daily updates, etc. Please note that 0 is used to disable NTP.

Time zone: Select the appropriate time zone from the list. If you want to upload Daylight Savings Time rules, please refer to System → Maintenance → Import/Export files on page 59 for details.

2.6.2 Homepage layout

This section explains how to set up your own customized homepage layout.

General settings

This part shows the settings of your homepage layout. You can manually select the background and font colors in Theme Options (the second tab on this page). The settings will be displayed automatically in this Preview field. The following shows the homepage using the default settings:



Customized button

If you want to hide manual trigger buttons on the homepage, please uncheck this item. This item is checked by default.



Theme Options

Here you can change the color of your homepage layout. There are three types of preset patterns for you to choose from. The new layout will simultaneously appear in the Preview filed. Click Save to enable the settings.

Background Color of the Control Area

Font Color of the Video Title

Font Color of the Configuration Area

Background color of the Video Area

Background Color of the Configuration Area

Frame Color

Preset Pattern

Font Color

Follow the steps below to set up the customized homepage:

1. Click Custom on the left column.
2. Click the field where you want to change the color on the right column.

Custom Pattern

Color Selector

3. The palette window will pop up as shown below.

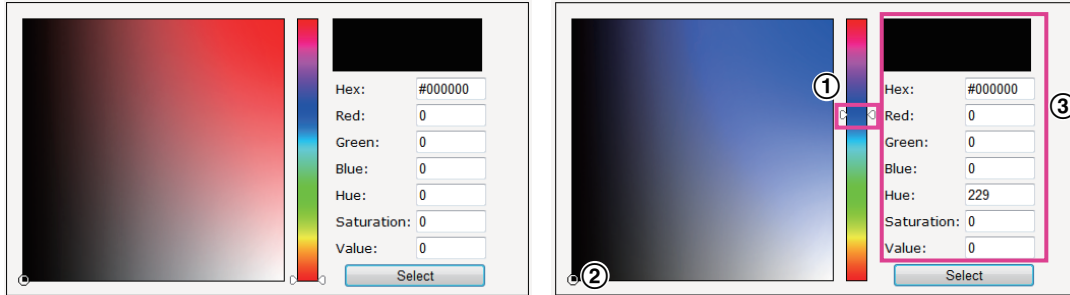

4. Drag the slider bar and click on a spot on the left square to select a desired color.
5. The selected color will be displayed in the corresponding fields and in the Preview column.
6. Click Save to enable the settings.

2.6.3 Logs

This section explains how to configure the KX-NTV150/KX-NTV160 to send the system log to a remote server as backup.

Log server settings

Follow the steps below to set up the remote log:

1. Select Enable remote log.
2. In the IP address text box, enter the IP address of the remote server.
3. In the port text box, enter the port number of the remote server.
4. When completed, click Save to enable the setting.

You can configure the KX-NTV150/KX-NTV160 to send the system log file to a remote server as a log backup. Before utilizing this feature, it is suggested that the user install a log-recording tool to receive system log

messages from the KX-NTV150/KX-NTV160. An example is Kiwi Syslog Daemon. Visit <http://www.kiwisyslog.com/kiwi-syslog-daemon-overview/>.

The screenshot shows the Panasonic configuration interface. The top navigation bar includes 'Home', 'Client settings', 'Configuration', and 'Language'. The main menu on the left lists various system settings: System, General settings, Homepage layout, Logs, Parameters, Maintenance, SIP, Media, Network, Security, PTZ, Event, Applications, and Recording. The 'System > Logs' section is active, displaying 'Log server settings' with the following configuration:

- Enable remote log
- IP address: 192.168.6.160
- Port: 514
- Syslog output level: 5

A 'Save' button is located at the bottom right of the settings panel. Below the settings, there are tabs for 'System log' and 'Access log'. The 'System log' tab is selected, showing a list of log entries. A window titled 'Kiwi Syslog Daemon (Version 7.1.4)' is overlaid on the log list, displaying a table of log messages:

Date	Time	Priority	Hostname	Message
11-04-2015	10:54:02	User.Debug	192.168.6.208	[STORMGR]: [Event_Read] processing "
11-04-2015	10:54:02	User.Info	192.168.6.208	[Chronos]: Sync with NTP server: <2015/11/03 10:30:37.159508>
11-04-2015	10:54:02	User.Debug	192.168.6.208	last message repeated 1303 times
11-04-2015	10:53:56	User.Debug	192.168.6.208	last message repeated 8001 times
11-04-2015	10:53:26	User.Debug	192.168.6.208	[STORMGR]: [Event_Read] processing "
11-04-2015	10:53:26	Cron.Info	192.168.6.208	crond[953]: crond: USER root pid 24838 cmd [sh /usr/bin/loadbalance.sh]
11-04-2015	10:53:26	User.Debug	192.168.6.208	last message repeated 6451 times
11-04-2015	10:53:01	User.Debug	192.168.6.208	[STORMGR]: [Event_Read] processing "
11-04-2015	10:53:01	User.Info	192.168.6.208	[Chronos]: Sync with NTP server: <2015/11/03 10:29:37.151288>
11-04-2015	10:53:01	User.Debug	192.168.6.208	last message repeated 315 times
11-04-2015	10:53:00	User.Debug	192.168.6.208	last message repeated 8153 times
11-04-2015	10:52:29	User.Debug	192.168.6.208	[STORMGR]: [Event_Read] processing "
11-04-2015	10:52:29	Syslog.Info	192.168.6.208	syslogd 1.5.0: restart.

System log

Input the SYSLOG output level from 0 to 7 levels, to filter the syslog by priority.

Log server settings

Enable remote log

IP address:

Port:

Syslog output level:

System log | **Access log**

```

Jan 15 11:18:14 [EVENT MGR]: Starting eventmgr with support for EcTun
Jan 15 11:18:14 udhcpd: deconfig
Jan 15 11:18:23 udhcpd: IP 192.168.6.145 netmask 255.255.255.0
Jan 15 11:18:23 udhcpd: router 192.168.6.1
Jan 15 11:18:23 udhcpd: dns 192.168.0.21 192.168.0.22
Jan 15 11:18:34 [VENC]: Day mode
Jan 15 11:18:37 [DRM Service]: Starting DRM service.
Jan 15 11:18:38 automount[607]: >> mount: mounting /dev/localstorage1 on /mnt/auto/CF failed:
No such file or directory
Jan 15 11:18:38 automount[607]: mount(generic): failed to mount /dev/localstorage1 (type auto)
on /mnt/auto/CF
Jan 15 11:18:38 automount[609]: >> mount: mounting /dev/localstorage1 on /mnt/auto/CF failed:
No such file or directory
Jan 15 11:18:38 automount[609]: mount(generic): failed to mount /dev/localstorage1 (type auto)
on /mnt/auto/CF
Jan 15 11:18:39 automount[613]: >> mount: mounting /dev/localstorage1 on /mnt/auto/CF failed:
No such file or directory
Jan 15 11:18:39 automount[613]: mount(generic): failed to mount /dev/localstorage1 (type auto)
on /mnt/auto/CF
Jan 15 11:18:39 [STORMGR]: [checkNull] [SQL_ExecAndWrite] Bad arguments. db is NULL
Jan 15 11:18:39 [STORMGR]: [SQL_ExecAndWrite] failed src/sqlengine.c:105
    
```

Code	Severity	General Description
0	Emergency	A "panic" condition usually affecting multiple apps/servers/sites. At this level it would usually notify all tech staff on call.
1	Alert	Should be corrected immediately, therefore notify staff who can fix the problem. An example would be the loss of a primary ISP connection.
2	Critical	Should be corrected immediately, but indicates failure in a secondary system, an example is a loss of a backup ISP connection.
3	Error	Non-urgent failures, these should be relayed to developers or administrators; each item must be resolved within a given time.

Code	Severity	General Description
4	Warning	Warning messages, not an error, but indication that an error will occur if action is not taken, e.g. files system 85% full-each item must be resolved within a given time.
5	Notice	Events that are unusual but not error conditions-might be summarized in an email to developers or administrators to spot potential problems-no immediate action required.
6	Informational	Normal operational messages-may be harvested for reporting, measuring throughput, etc.-no action required.
7	Debug	Information useful to developers for debugging the application, not useful during operations.

This column displays the system log in a chronological order. The system log is stored in the KX-NTV150/KX-NTV160 buffer area and will be overwritten when reaching a certain limit.

Access log

System log

Access log

```

Jan 15 11:39:32 [RTSP SERVER]: Start one session, IP=192.168.6.144
Jan 15 11:39:35 [RTSP SERVER]: Stop one session, IP=192.168.6.144
Jan 15 11:49:51 [RTSP SERVER]: Start one session, IP=192.168.6.144
Jan 15 11:50:36 [RTSP SERVER]: Stop one session, IP=192.168.6.144
Jan 15 11:50:38 [RTSP SERVER]: Start one session, IP=192.168.6.144

```

Access log displays the access time and IP address of all viewers (including operators and administrators) in a chronological order. The access log is stored in the KX-NTV150/KX-NTV160 buffer area and will be overwritten when it reaches a certain limit.

2.6.4 Parameters

The View Parameters page lists the entire system's parameters. If you need technical assistance, please provide the information listed on this page.

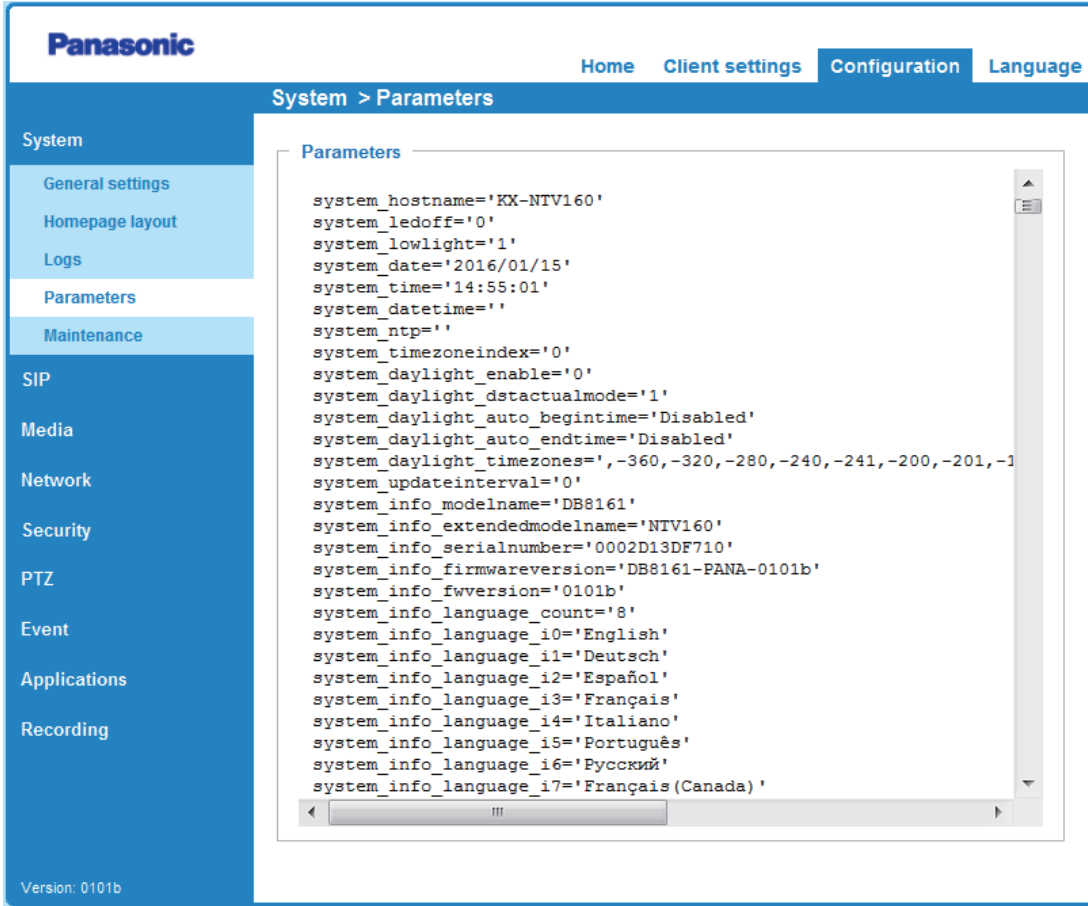

2.7 Maintenance

This section explains how to restore the KX-NTV150/KX-NTV160 to factory default, upgrade firmware version, etc.

2.7.1 General settings

2.7.1.1 Upgrade firmware

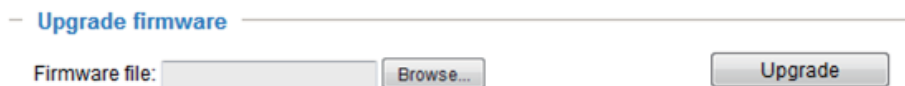

This feature allows you to upgrade the firmware of your KX-NTV150/KX-NTV160. It takes a few minutes to complete the process.

Note

- Do not power off the KX-NTV150/KX-NTV160 during the upgrade!

Follow the steps below to upgrade the firmware:

1. Download the latest firmware file from the Panasonic website. The file is in .pkg file format.
2. Click Browse... and specify the firmware file.
3. Click Upgrade. The KX-NTV150/KX-NTV160 starts to upgrade and will reboot automatically when the upgrade completes.

If the upgrade is successful, you will see "Reboot system now!! This connection will close". After that, re-access the KX-NTV150/KX-NTV160.

The following message is displayed when the upgrade has succeeded.

```
Starting firmware upgrade...
Do not power down the server during the upgrade.
The server will restart automatically after the upgrade is completed.
It will take about 1 - 5 minutes.
Pkg version: 1.1a.p1.1.39
Support script version : 0101a
System image size = 18981296
Unpack success
Stopping applications (about 10 seconds..)
Backup web files
Stopping configer: .
Stopping ectun: stopped ectun (pid 198)
.
Detach UBI
Set mnt flash recover mode
"flashstatus" write successfully!
Backup config file
Upgrade firmware
"flashstatus" write successfully!
Backup user data
Set upgrade mode
"flashstatus" write successfully!
Reboot system now !!
This connection will close
```

The following message is displayed when you have selected an incorrect firmware file.

```
Starting firmware upgrade...
Do not power down the server during the upgrade.
The server will restart automatically after the upgrade is completed.
It will take about 1 - 5 minutes.
Pkg version: 1.1a.m1.1.a3
Support script version : 0101a
System image size = 17330765
The model type is not compatible.
Invalid pkg version 1.
Unpack fail...system is rebooting...
```

2.7.1.2 Reboot

This feature allows you to reboot the KX-NTV150/KX-NTV160, which takes about one minute to complete. When completed, the live video page will be displayed in your browser. The following message will be displayed during the reboot process.

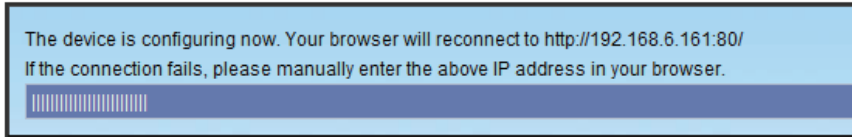

If the connection fails after rebooting, manually enter the IP address of the KX-NTV150/KX-NTV160 in the address field to resume the connection.

2.7.1.3 Restore

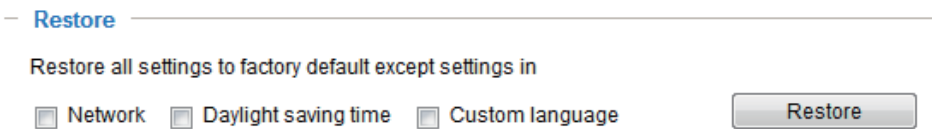

This feature allows you to restore the KX-NTV150/KX-NTV160 to factory default settings.

Network: Select this option to retain the Network Type settings (please refer to Network Type on page 78).

Daylight saving time: Select this option to retain the Daylight saving time settings (please refer to Import/Export files below on this page).

Custom language: Select this option to retain the Custom language settings.

If none of the options are selected, all settings will be restored to factory default. The following message is displayed during the restoring process.

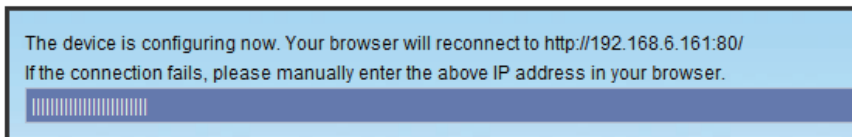

Import/Export files

This feature allows you to Export/Update daylight saving time rules, custom language file, configuration file, and server status report.

The screenshot shows a web interface with two tabs: "General settings" and "Import/Export files". The "Import/Export files" tab is selected. The interface is divided into two main sections: "Export files" and "Upload files".

Export files section:

- Export Setting Configuration: [Export]
- Export daylight saving time configuration file: [Export]
- Export language file: [Export]
- Export Backup Configuration: [Export]
- Export server status report: [Export]

Upload files section:

- Update Setting Configuration: [Text Input] [Browse...] [Upload]
- Update daylight saving time rules: [Text Input] [Browse...] [Upload]
- Update custom language file: [Text Input] [Browse...] [Upload]
- Upload Backup Configuration: [Text Input] [Browse...] [Upload]

Export daylight saving time configuration file: Click to set the start and end time of DST (Daylight Saving). Follow the steps below to export:

1. In the Export files column, click Export to export the daylight saving time configuration file from the KX-NTV150/KX-NTV160.
2. A file download dialog will be displayed. Open the XML file to review it, or save it for editing.
3. Open the file with Microsoft Notepad and locate your time zone; set the start and end time of DST. When completed, save the file.

In the example below, DST begins each year at 2:00 a.m. on the second Sunday in March and ends at 2:00 a.m. on the first Sunday in November.

```

</EndTime>
</TimeZone>
<TimeZone id="-240" name="(GMT-06:00) Central Time (US
and Canada)">
  <StartTime>
    <Shift>60</Shift>
    <Month>3</Month>
    <Day></Day>
    <WeekinMonth>Second</WeekinMonth>
    <DayofWeek>Sunday</DayofWeek>
    <Hour>2</Hour>
  </StartTime>
  <EndTime>
    <Shift>-60</Shift>
    <Month>11</Month>
    <Day></Day>
    <WeekinMonth>First</WeekinMonth>
    <DayofWeek>Sunday</DayofWeek>
    <Hour>2</Hour>
  </EndTime>
</TimeZone>
<TimeZone id="-241" name="(GMT-06:00) Mexico City">
  <StartTime>
    <Shift>60</Shift>
    <Month>4</Month>
    <Day></Day>
    <WeekinMonth>First</WeekinMonth>
    <DayofWeek>Sunday</DayofWeek>
    <Hour>2</Hour>
  </StartTime>
  <EndTime>
    <Shift>-60</Shift>
    <Month>10</Month>
    <Day></Day>
    <WeekinMonth>Last</WeekinMonth>
    <DayofWeek>Sunday</DayofWeek>
    <Hour>2</Hour>
  </EndTime>
</TimeZone>

```

Update daylight saving time rules: Click Browse... and specify the XML file to update. If the incorrect date and time are assigned, you will see the following warning message when uploading the file to the KX-NTV150/KX-NTV160.

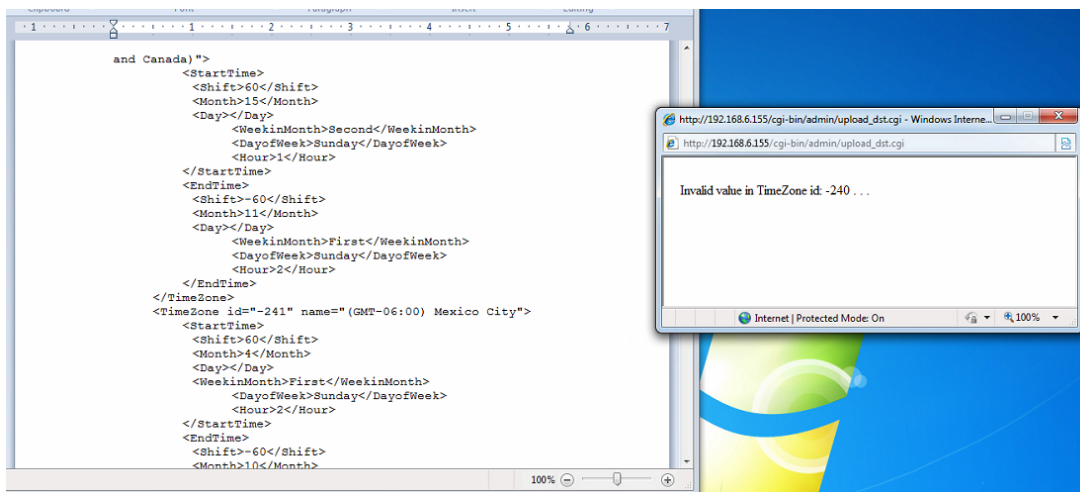

An error message is displayed when attempting to upload an incorrect file format.
Export language file: Click to export language strings. Panasonic provides eight languages: English, Spanish, French, Italian, German, Portuguese, Russian, and Canadian French
Update custom language file: Click Browse... and specify your own custom language file to upload.

Export Backup Configuration: Click to export all parameters for the device and user-defined scripts.

Upload Backup Configuration: Click Browse... to update a configuration file. Please note that the model and firmware version of the device should be the same as the configuration file. If you have set up a fixed IP or other special settings for your device, it is not suggested to update a configuration file.

Export server status report: Click to export the current server status report, such as time, logs, parameters, process status, memory status, file system status, network status, kernel message and so on.

Export Setting Configuration: Click Export button to export the SIP setting. This allows users to save their personal SIP settings.

Update Setting Configuration: Click Upload to upload the SIP configuration file. This allows users to use the settings they saved before.

2.8 SIP

2.8.1 General Settings

The KX-NTV150/KX-NTV160 are designed to be used like a SIP device; users can set the outgoing number and SIP status timer under SIP → General settings page.

The screenshot displays the Panasonic SIP General settings page. The interface includes a navigation menu on the left with categories like System, SIP, Media, Network, Security, PTZ, Event, Applications, and Recording. The main content area is titled 'SIP > General settings' and contains two sections:

- Call button outgoing number:** Features a radio button for 'Basic mode' (selected) and 'Advanced mode'. Below it is a text input field for 'Outgoing number' containing the value '137'.
- General settings:** Contains several configuration options:
 - 'Call ring duration' set to '30' seconds.
 - 'Call duration' set to '0' seconds.
 - 'Video monitor before answer' (checkbox, unchecked).
 - 'Ringback tone after finish video monitor' (checkbox, unchecked).
 - 'Indication of call status when receiving call' (checkbox, checked).

A 'Save' button is located at the bottom right of the settings area. The version number 'Version: 0101b' is visible in the bottom left corner.

Call button outgoing number:

User can enter the SIP phone number they wants to outgoing. KX-NTV150/KX-NTV160 provide two mode for user to set.

Basic mode: User can simply enter one outgoing number.

Call button outgoing number

Basic mode

Outgoing number

Advanced mode

Advanced mode:

Call button outgoing number

Basic mode

Advanced mode

Day

Outgoing number

Starting time

Lunch

Outgoing number

Starting time

Break

Outgoing number

Starting time

Ending time

Day 2

Starting time

Night

Outgoing number

Starting time

With the setting, make SIP outgoing according to time setting (Day/Lunch/Break/Day2/Night).

By Time mode, users can divide one day into Day/Lunch/Break/Day2/Night time periods.

Set the time period with the following rules:

- Day/Lunch/Day2/Night only need to set START time.
- The next START point of time period is the previous END point of time period.
- If the time period or number setting are blank, skip the time period then start the next time period.

Example:

If you set

Day1: start from 9:00

Lunch: start from 12:00

Break: Start from 14:00 to 16:00

Day2: Start from 14:00
 Night: start from 17:00
 Then we can get below time period:
 Day1: 9:00~12:00
 Lunch: 12:00~14:00
 Break: 14:00~16:00
 Day2: 16:00~17:00
 Night: 17:00~09:00

- Only Break can set START/END time, it has a higher priority than other periods.
- SIP outgoing Number of Day/Day2 is the same phone number.

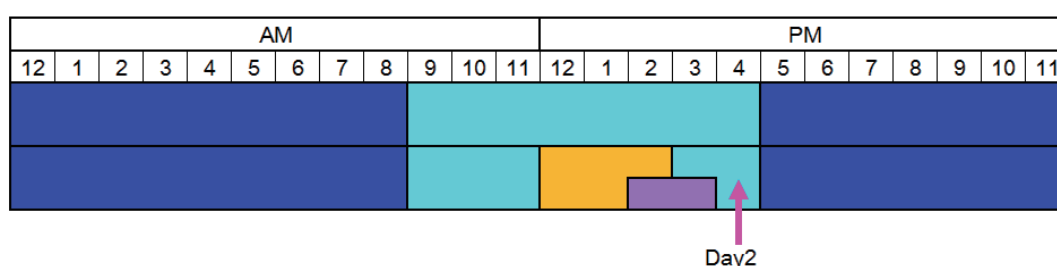

General settings

Call ring duration second

Call duration second

Video monitor before answer

Ringback tone after finish video monitor

Indication of call status when receiving call

Call ring duration: (10 seconds–150 seconds)

Set the remaining time during outgoing, once exceed the setting, SIP outgoing call will be stopped.

Call duration: (0-300 seconds, 0: No limit)

Set the time during conversation.

Video monitor before answer:

This function is for users who use SIP Video Device and IP Camera/IP Video Doorphone, and is used to determine if users want to open the door or answer the phone or not by monitoring the video. For example, if on the side of IP Camera/doorphone, someone presses the call button. At that time, if the callee hooks off the SIP video device, the callee can monitor the video. However the user at the side of Communication IP camera/IP Video Doorphone is not aware of that someone is motoring the video, the caller only can hear the ringback tone until exceed the time of "Call ring duration". Once the callee press Dial Key* on SIP video

device after hooking off and before Call ring duration, the two-way audio will be started just like normal conversation on a phone.

* If the SIP device on the callee side is Audio only, two-way audio will be automatically started.

Ringback tone after finish video monitor:

Once YES is selected for this item, if the caller hook on the phone during video monitoring, the SIP outgoing will be stopped. The caller still can only hear ringback tone, and the user is not aware that the SIP outgoing has stopped.

Indication of call status when receiving call:

Once "Yes" is selected for this item, the caller can see the LED status and hear confirmation tone to know that the conversation has started or ended.

2.8.2 SIP Settings

SIP Settings	
Phone Number	138
Registrar Server Address	172.16.100.10
Registrar Server Port	5060
Proxy Server Address	172.16.100.10
Proxy Server Port	5060
Service Domain	172.16.100.10
Authentication ID	138
Authentication Password	••••••••••

SIP Settings

User can set the PBX server IP address, and related authentication information in this page, to register to PBX.

- **Phone Number:** Specifies the phone number to use as the user ID required for registration to the SIP registrar server.

- **Registrar Server Address:** Specifies the IP address or FQDN of the SIP registrar server.
- **Registrar Server Port:** Specifies the port number to use for communication with the SIP registrar server.
- **Proxy Server Address:** Specifies the IP address or FQDN of the SIP proxy server.
- **Proxy Server Port:** Specifies the port number to use for communication with the SIP proxy server.
- **Service Domain:** Specifies the domain name provided by your phone system dealer. The domain name is the part of the SIP URI that comes after the "@" symbol.
- **Authentication ID:** Specifies the authentication ID required to access the SIP server. Please input the same value as the phone number.
- **Authentication Password:** Specifies the authentication password used to access the SIP server.

2.9 Media

2.9.1 Image

This section explains how to configure the image settings of the KX-NTV150/KX-NTV160. It is composed of the following four tabs: General settings, Image settings, Exposure, and Privacy mask.

General settings

Video title: Enter a name that will be displayed on the title bar of the live video as the picture shown below.

Show timestamp and video title in video and snapshots: Select this checkbox if you prefer video title and time stamp to display in videos and snapshots.

A zoom indicator will be displayed on the Home page when you zoom in/out on the live viewing window as shown below. You may zoom in/out on the image by scrolling the mouse wheel inside the live viewing window and the maximum zoom in will be up to 12.5 times.



Video font (.ttf): Upload the language .ttf file to support display special language on OSD.

Color: Select to display color or black/white video streams.

Power line frequency: Set the power line frequency consistent with local utility settings to eliminate image flickering associated with fluorescent lights. Note that after the power line frequency is changed, you must disconnect and reconnect the power cord of the KX-NTV150/KX-NTV160 in order for the new setting to take effect.

Video orientation: Flip to vertically reflect the display of the live video; Mirror to horizontally reflect the display of the live video. Select both options if the KX-NTV150/KX-NTV160 is installed upside-down (e.g., on the ceiling) to correct the image orientation.

Rotate to rotate the live video to 90 degrees and 270 degrees.

Rotate Degrees

Please note that if you have configured preset locations, those locations will be cleared after flip/mirror setting.

Light source LED settings: With the setting "Manual emitting activate" checked, you can manually emit the Light source LED on the home view page.

CAUTION

- "Manual emitting activate" settings take priority over "Emitting control after call button pushed" settings. If you enable "Light source LED settings" on the home view page, you must later turn off "Light source

LED settings" on home view page. If you do not do this, the Light source LED will always turn on when power supply is being supplied to the KX-NTV160.

Light source LED settings:

Manual emitting activate

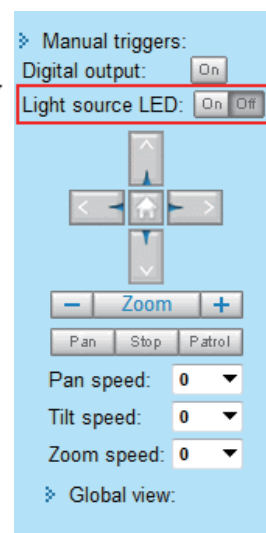

Emitting control after call button pushed: You can select Always on/Always off/Time schedule.

If you select Always on, it means that once you press the call button, the Light source LED is ON during SIP outgoing.

If you select Always off, it means that once you press the call button, the Light source LED is OFF during SIP outgoing.

If you select Time schedule, it means that once you press the call button, the Light source LED is ON According to the time range.

Light source LED settings:

Manual emitting activate

Emitting control after call button pushed:

Time schedule ▼

From: 18:00 to: 06:00

Image settings

On this page, you can tune the White balance, Image adjustment and low light compensation.

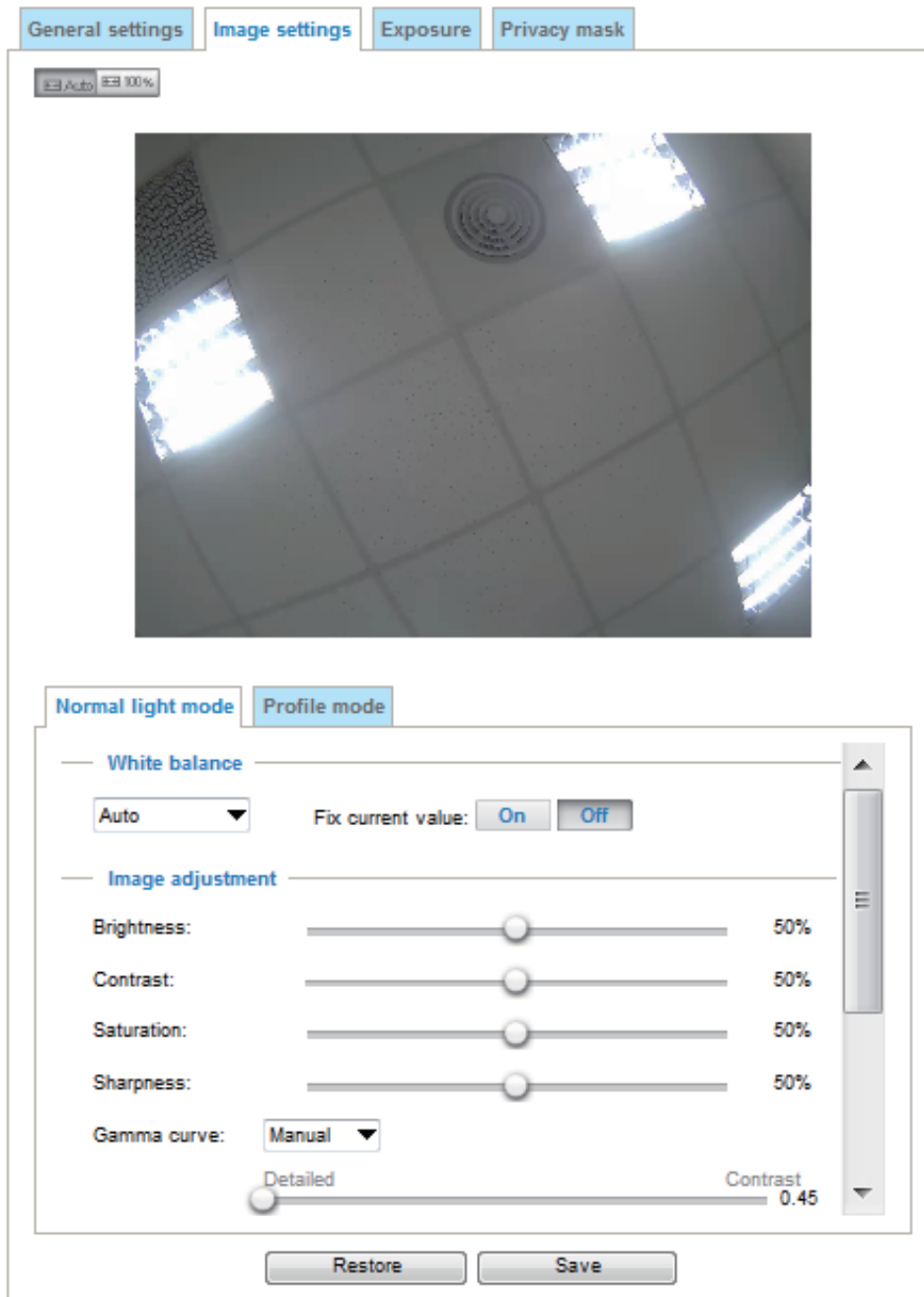

White balance: Adjust the value for the best color temperature.

You can follow the steps below to adjust the white balance to the best color temperature.

1. Place a sheet of paper of white or cooler-color temperature paper, such as blue, in front of the lens, then allow the KX-NTV150/KX-NTV160 to automatically adjust the color temperature.
2. Click the ON button to Fix current value and confirm the setting while the white balance is being measured.

Image Adjustment

- **Brightness:** Adjusts the image brightness level, which ranges from 0%-100%.
- **Contrast:** Adjusts the image contrast level, which ranges from 0%-100%.
- **Saturation:** Adjusts the image saturation level, which ranges from 0%-100%.
- **Sharpness:** Adjusts the image sharpness level, which ranges from 0%-100%.
- **Gamma curve:** Adjusts the Gamma curve. The default is Optimize and you can adjust it manually.



- **Defog:** Clears images even if the weather is poor, such as when there is smog, fog, or smoke.
- **Enable 3D noise reduction:** Check to enable noise reduction in order to reduce noises and flickers in images. This applies to the onboard 3D Noise Reduction feature. Use the pull-down menu to adjust the reduction strength. Note that applying this function to the video channel will consume system computing power.

3D Noise Reduction is mostly applied in low-light conditions. When enabled in a low-light condition with fast moving objects, trails of after-images may occur. You may then select a lower strength level or disable the function.

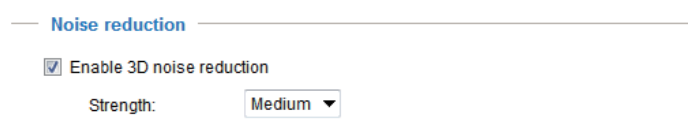

You can click Restore to recall the original settings without incorporating the changes. When completed with the settings on this page, click Save to enable the setting. You can also click on Profile mode to adjust all settings above in a pop-up window for special lighting conditions. You may select the scheduled mode to set the period which you prefer a different lighting and image settings.

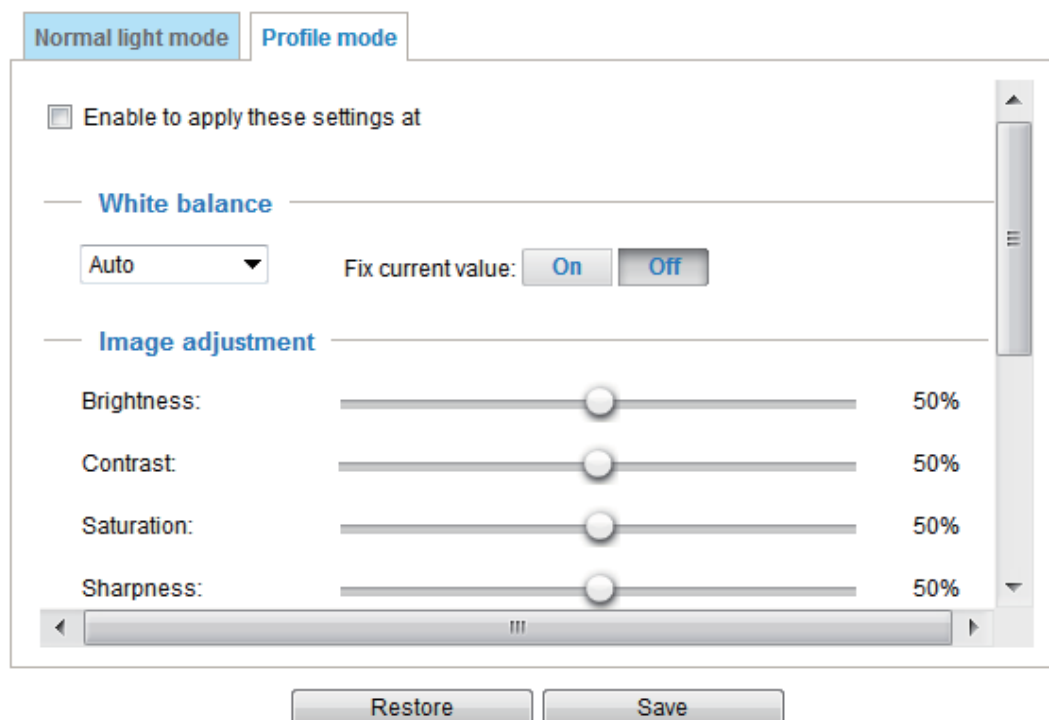

Exposure

On this page, you can set the Measurement window, Exposure level, Exposure time, Gain, and WDR settings. Detailed configurations will be automatically adjusted since the sensor library will automatically adjust the value according to the ambient light.

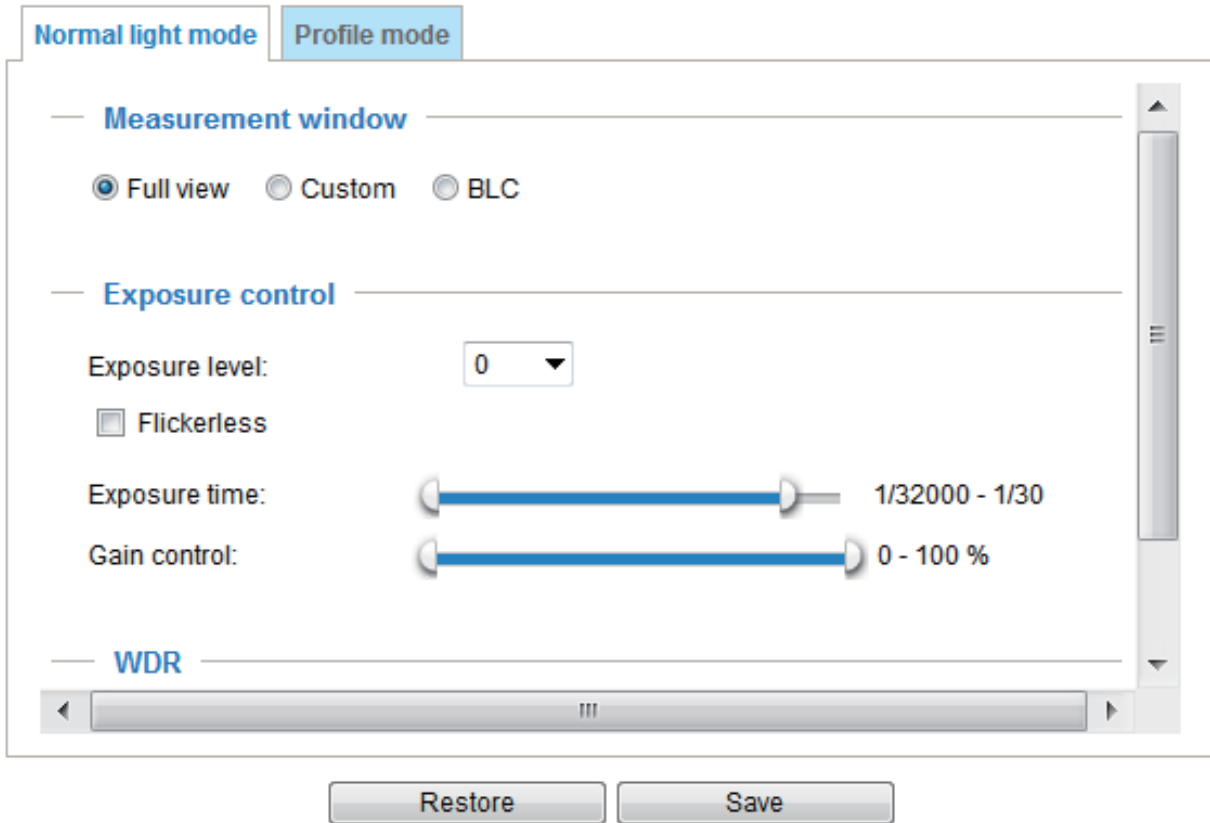

You can click on the Profile button to configure an individual setting that will take effect for a different period of time. For example, in the night time, you may prefer different lighting and image settings.

Schedule mode: Select the period of time this profile setting will apply to. Please manually enter a range of time in a day, tune the White Balance and Image adjustment settings as previously described, and then click Save for the configuration to take effect.

Enable to apply these settings at

Schedule mode : From to [hh:mm]

Measurement window: This function allows users to set measurement window(s) for low light compensation.

- **Full view:** Calculate the full range of view and offer appropriate light compensation.
- **Custom:** This option allows you to manually add specific windows as measuring areas. The measuring window refers to "weighed window" where the lighting condition within the particular area is taken into account. KX-NTV150/KX-NTV160 firmware then adopts the weighted averages method to calculate the value. A total of 9 inclusive and exclusive windows can be created for a view. You can create Exclude windows for the KX-NTV150/KX-NTV160 to ignore the lighting condition of certain areas. Note that the title pane of the Include/Exclude windows is not included into the calculation.
- **BLC (Back Light Compensation):** This option allows you to use the center of the current view as the measuring area. The measuring window refers to "weighted window" where the lighting condition within

the particular area is taken into account. KX-NTV150/KX-NTV160 firmware then adopts the weighted averages method to calculate the value and provides necessary light compensation.

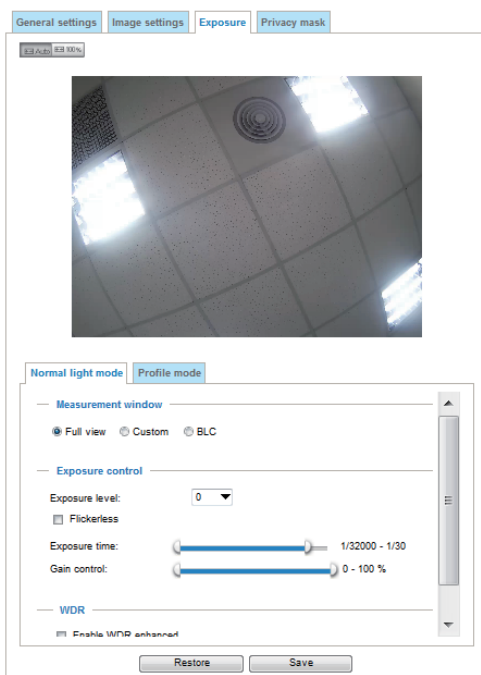

A total of 9 inclusive and exclusive windows can be created for a view. You can create Exclude windows for the KX-NTV150/KX-NTV160 to ignore the lighting condition of certain areas. Note that the title pane of the Include/Exclude windows is not included into the calculation.

Profile mode: Select the period of time this profile setting will apply to. Please manually enter a range of time in a day, the Measurement window and Exposure control settings, and then click Save for the configuration to take effect.

Please follow the steps below to setup a profile:

1. Select Enable and apply this profile to.
2. Select Schedule time by entering a range of time for this profile to apply to.
3. Select the Measurement window setting.
4. Configure Exposure control settings in the following columns. Please refer to previous discussions for detailed information.

5. Click Save to enable the setting and click Close to exit the page.

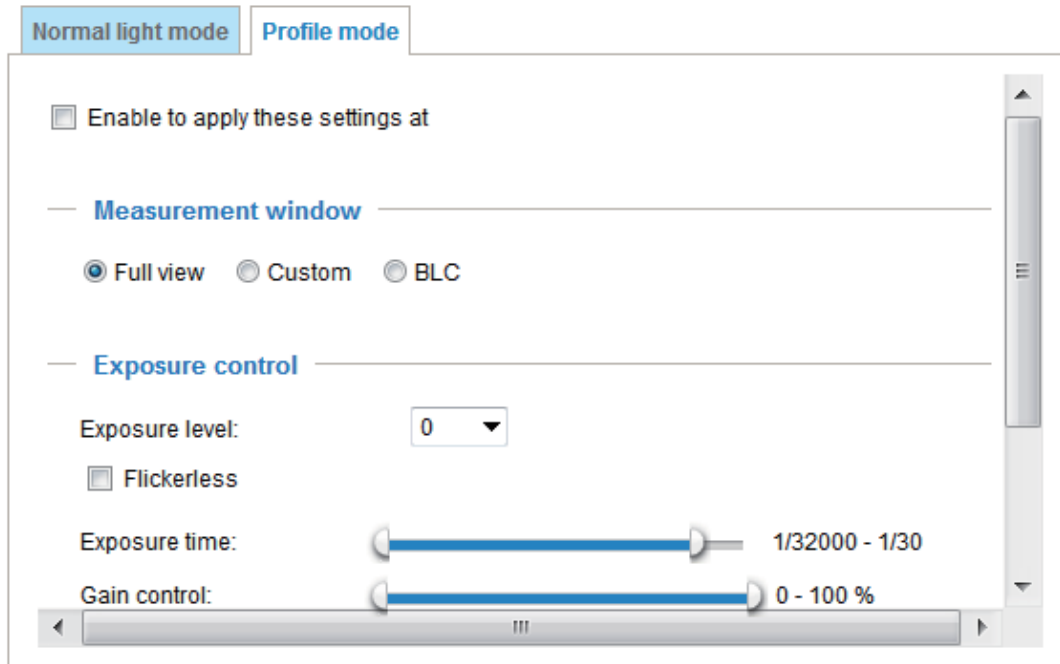

Exposure control:

- **Exposure level:** You can manually set the Exposure level, which ranges from -2.0 to +2.0 (dark to bright).
- **Flickerless:** This function helps avoid the flickering on images because of the fast shutter movement and the inconsistency between power line frequency (50 or 60 Hz) and exposure time. When selected, the exposure time will be forced to stay longer than 1/120 second. For KX-NTV150/KX-NTV160 that come with fixed iris lens, setting the exposure time to longer than 1/120 second may introduce too much light into the lens. Users can use this option to observe whether the result of long exposure time is satisfactory or not.
- **Exposure time:** you can split the round pointers on the Exposure time and Gain control slide bars into two halves and drag them on the bars to designate a range of values in which firmware can automatically adapt to. Note that Firmware will then automatically tune the Gain, Exposure time, and Iris opening within the ranges you specified. For example, in low-light condition, you may prefer a longer exposure time and more electronic gains. However, the noises in the image will also increase.
- **Gain control:** Tune the slider bar to set the Gain control to the best image quality. Higher gain control value will generate a certain amount of noises, and that the gain control, lighting levels, and picture performance is closely related.

Click the Save button to preserve your configuration.

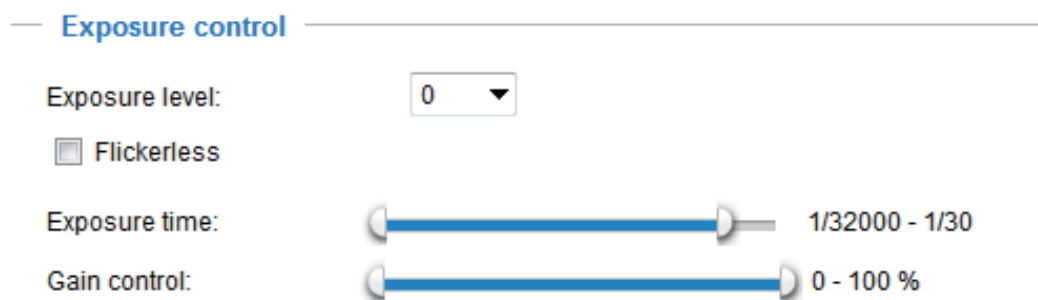

Privacy mask

Click Privacy mask to open the settings page. On this page, you can block out sensitive zones to address privacy concerns.

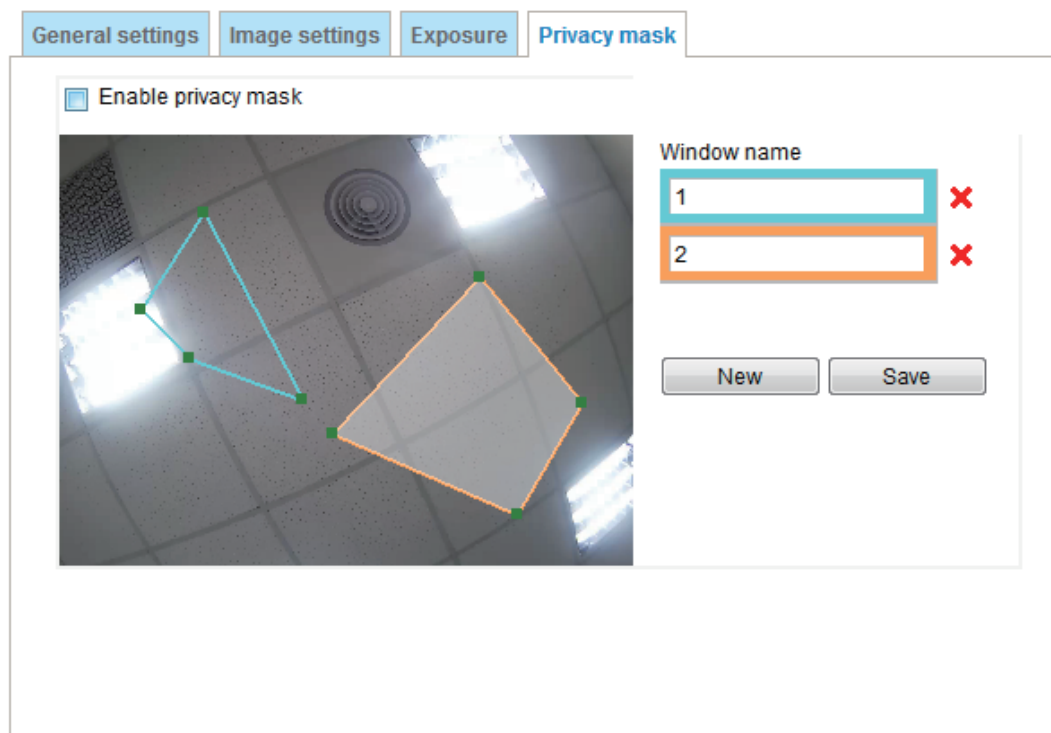

To set the privacy mask windows, follow the steps below:

1. Click New to add a new window.
2. You can use the mouse cursor to size and drag-drop the window, which is recommended to be at least twice the size of the object (height and width) you want to cover.
3. Enter a Window name and click Save to enable the setting.
4. Click on the Enable privacy mask checkbox to enable this function.

Note

- Up to 5 privacy mask windows can be set up on the same screen.
- If you want to delete the privacy mask window, please click the 'x' mark on the upper right corner of the window.

2.9.2 Video

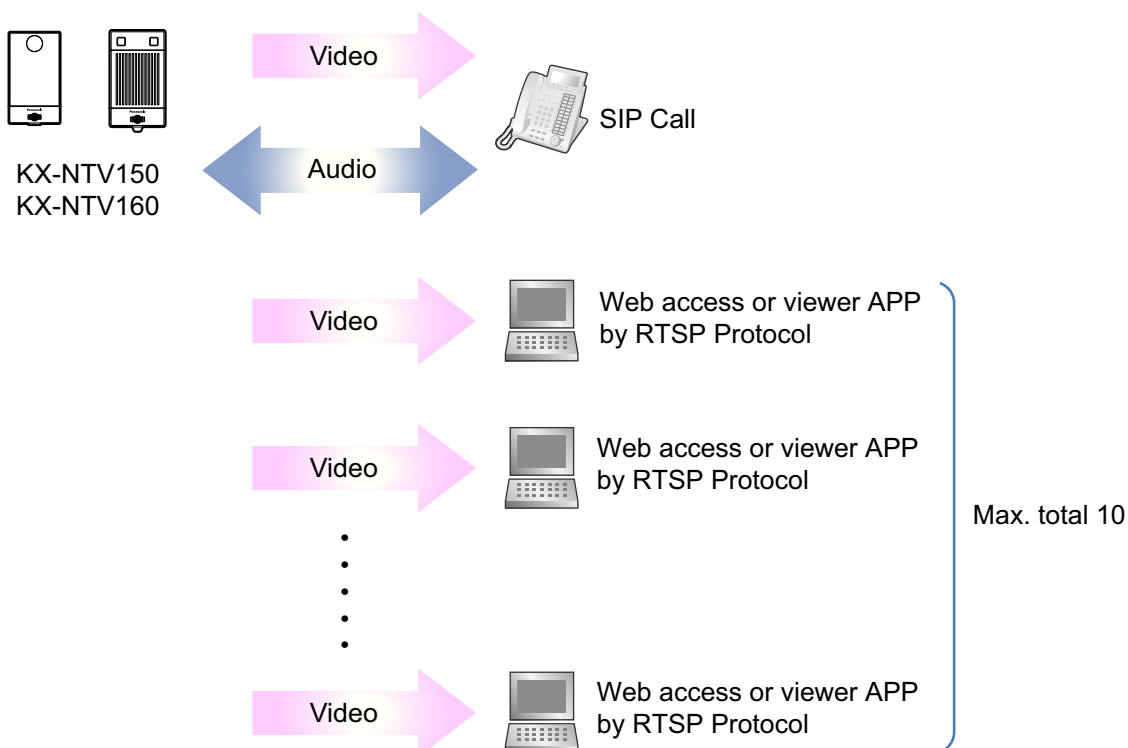

KX-NTV150/KX-NTV160 can accept one SIP connection and a maximum of 10 RTSP connections. During a SIP call, other RTSP clients can only view video without two-way audio functions. When one RTSP client is operating ePTZ, ROI (region of interest) of other RTSP clients is affected at the same time. On the video settings page, stream 1 is the setting for RTSP streaming, and stream 2 is the setting for SIP streaming. This KX-NTV150/KX-NTV160 supports multiple streams with a frame size ranging from 176x144 to 1600x1200. The definition of multiple streams:

- **Stream 1 (RTSP):** Stream1 default is set to 1280x960 for user to view video through WEB UI. Users can change codec to H.264 or MJPEG.
- **Stream 2 (SIP):** Stream2 default is set to VGA for users to view video through SIP Video phone. Users can only select H.264 for SIP.

This KX-NTV150/KX-NTV160 provides real-time H.264 and MJPEG compression standards (Dual Codec) for real-time viewing (Stream2 is H.264 only). If H.264 mode is selected, the video is streamed via RTSP protocol. There are several parameters for you to adjust the video performance:

Stream

✦ Video settings for stream 1 (RTSP)

H.264

Frame size:

Maximum frame rate:

Intra frame period:

Video quality

Constant bit rate:

Fixed quality:

Quality:

Maximum bit rate:

JPEG

✦ Video settings for stream 2 (SIP)

H.264

Frame size:

Maximum frame rate:

Intra frame period:

Video quality

Constant bit rate:

Fixed quality:

Quality:

Maximum bit rate:

Frame size

You can set up different video resolutions for different viewing devices. For example, set a smaller frame size and lower bit rate for remote viewing on mobile phones and a larger video size and a higher bit rate for live viewing on web browsers. Note that a larger frame size takes up more bandwidth.

Camera support below resolutions:

1600x1200, 1280x960, 1280x720, 1024x768, 640x480, 640x360, 386x216, 352x288, 320x240, and 176x144.

Maximum frame rate

This limits the maximum refresh frame rate per second. Set the frame rate higher for smoother video quality and for recognizing moving objects in the field of view.

If the power line frequency is set to 50 Hz, the selectable frame rates are 5 fps, 8 fps, 10 fps, 15 fps, 20 fps, and 25 fps. If the power line frequency is set to 60 Hz, the frame rates are selectable at 5 fps, 8 fps, 10 fps, 15 fps, 20 fps, 25 fps, and 30 fps. You can also select Customize and manually enter a value.

The frame rate will decrease if you select a higher resolution.

Note

- If CPU loading get high, due to performance limitation, framerate maybe can not meet the current setting.

Intra frame period

Determine how often to plant an I frame. The shorter the duration, the more likely you will get better video quality, but at the cost of higher network bandwidth consumption. Select the intra frame period from the following durations: 1/4 second, 1/2 second, 1 second, 2 seconds, 3 seconds, and 4 seconds.

Video quality

Constant bit rate:

Target bit rate:

A complex scene generally produces a larger file size, meaning that higher bandwidth will be needed for data transmission. To regulate the bandwidth consumption and storage space for recording videos, you can select the Constant bit rate methodology. The firmware will try its best to contain the size of video packets within the limitation of a constant bit rate. This methodology enables easier calculation of the network bandwidth and storage space required for live viewing or video recording.

The bandwidth utilization is configurable to match a selected level, resulting in mutable video quality performance. The bit rates are selectable at the following rates: 20 Kbps, 30 Kbps, 40 Kbps, 50 Kbps, 64 Kbps, 128 Kbps, 256 Kbps, 512 Kbps, 768 Kbps, 1 Mbps, 2 Mbps, 3 Mbps, 4 Mbps, 6 Mbps, and 8 Mbps. You can also select Customize and manually enter a value.

Fixed quality: On the other hand, if Fixed quality is selected, all frames are transmitted with the same quality; bandwidth utilization is therefore unpredictable. The video quality can be adjusted to the following settings: Medium, Standard, Good, Detailed, and Excellent. You can also select Customize and manually enter a value.

Maximum bit rate:

Target bit rate:

With the guaranteed image quality, you might still want to place a bit rate limitation to control the size of video streams for bandwidth and storage concerns. The configurable bit rate starts from 1 Mbps to 8 Mbps. The Maximum bit rate setting in the Fixed quality configuration can ensure a reasonable and limited use of network bandwidth. For example, in low light conditions where a Fixed quality setting is applied, video packet sizes can tremendously increase when noises are produced with electrical gain.

You may also manually enter a bit rate number by selecting the Customized option.

2.9.3 Audio

Volume Control

The screenshot shows the 'Volume Control' settings page. It has two tabs: 'Volume Control' (selected) and 'Audio type'. Under 'Volume Control', there are two 'Mute' checkboxes, both unchecked. Below each 'Mute' checkbox is a gain control: 'Internal microphone input gain' and 'Internal speaker output gain', both set to 'Level 2' in a dropdown menu. A 'Save' button is located at the bottom right of the panel.

Internal microphone input gain: Select the gain of the external audio input from the drop-down list (Level 1, Level 2, and Level 3) according to ambient conditions.

Internal speaker output gain: Select the gain of the external audio output from the drop-down list (Level 1, Level 2, and Level 3) according to ambient conditions.

Audio type:

The screenshot shows the 'Audio type' settings page. It has two tabs: 'Volume Control' and 'Audio type' (selected). Under 'Audio type', there are two sections: 'Audio type (Codec) for RTSP' and 'Audio type (Codec) for SIP'. In the RTSP section, 'G.711' is selected with a radio button, and the dropdown menu shows 'pcmu'. In the SIP section, 'G.722' is selected with a radio button, and the dropdown menu shows 'pcma'. A 'Save' button is located at the bottom right of the panel.

- G.711 provides pcma (a-law), pcmu (u-Law) mode for RTSP and SIP.
- G.722 and G.729a, provides for SIP audio.

When completed with the settings on this page, click Save to enable the settings.

2.10 Network

2.10.1 General settings

This section explains how to configure a wired network connection for the KX-NTV150/KX-NTV160.

Network type

The screenshot shows a configuration window with two tabs: "Network type" and "Port". The "Network type" tab is active. It contains the following options:

- LAN
 - Get IP address automatically
 - Use fixed IP address
 - Enable UPnP presentation
 - Enable UPnP port forwarding
- PPPoE

A "Save" button is located at the bottom right of the window.

LAN: Select this option when the KX-NTV150/KX-NTV160 is deployed on a local area network (LAN) and is intended to be accessed by local computers. The default setting for the Network Type is LAN. Please remember to click Save when you complete the Network setting.

Get IP address automatically: Select this option to obtain an available dynamic IP address assigned by the DHCP server each time the KX-NTV150/KX-NTV160 is connected to the LAN.

Use fixed IP address: Select this option to manually assign a static IP address to the KX-NTV150/KX-NTV160.

The screenshot shows a configuration window with two tabs: "Network type" and "Port". The "Network type" tab is active. Under "LAN", there are three radio button options: "LAN" (selected), "Get IP address automatically", and "Use fixed IP address". Below "Use fixed IP address", there are seven input fields: "IP address" (192.168.6.145), "Subnet mask" (255.255.255.0), "Default gateway" (192.168.6.1), "Primary DNS" (192.168.0.21), "Secondary DNS" (192.168.0.22), "Primary WINS server" (192.168.0.21), and "Secondary WINS server" (192.168.0.22). There are two checkboxes: "Enable UPnP presentation" (checked) and "Enable UPnP port forwarding" (unchecked). At the bottom left, there is a radio button for "PPPoE". A "Save" button is located at the bottom right.

1. You can make use of Panasonic Installation Wizard to easily set up the KX-NTV150/KX-NTV160 on LAN. Please refer to Software Installation on page 35 for details.
2. Enter the Static IP, Subnet mask, Default gateway, and Primary DNS provided by your ISP or consult your network administrator.

Subnet mask: This is used to determine if the destination is in the same subnet. The default value is "255.255.255.0".

Default gateway: This is the gateway used to forward frames to destinations in a different subnet. Invalid router setting will fail to send the transmission to destinations in different subnets.

Primary DNS: The primary domain name server that translates hostnames into IP addresses.

Secondary DNS: Secondary domain name server that backups the Primary DNS.

Primary WINS server: The primary WINS server that maintains the database of computer names and IP addresses.

Secondary WINS server: The secondary WINS server that maintains the database of computer names and IP addresses.

Enable UPnP presentation: Select this option to enable UPnP presentation for your KX-NTV150/KX-NTV160 so that whenever KX-NTV150/KX-NTV160 are presented to the LAN, shortcuts of connected

2 Software

KX-NTV150/KX-NTV160 will be listed in My Network Places. You can click the shortcut to link to the web browser. Note that to utilize this feature, please make sure the UPnP component is installed on your computer.

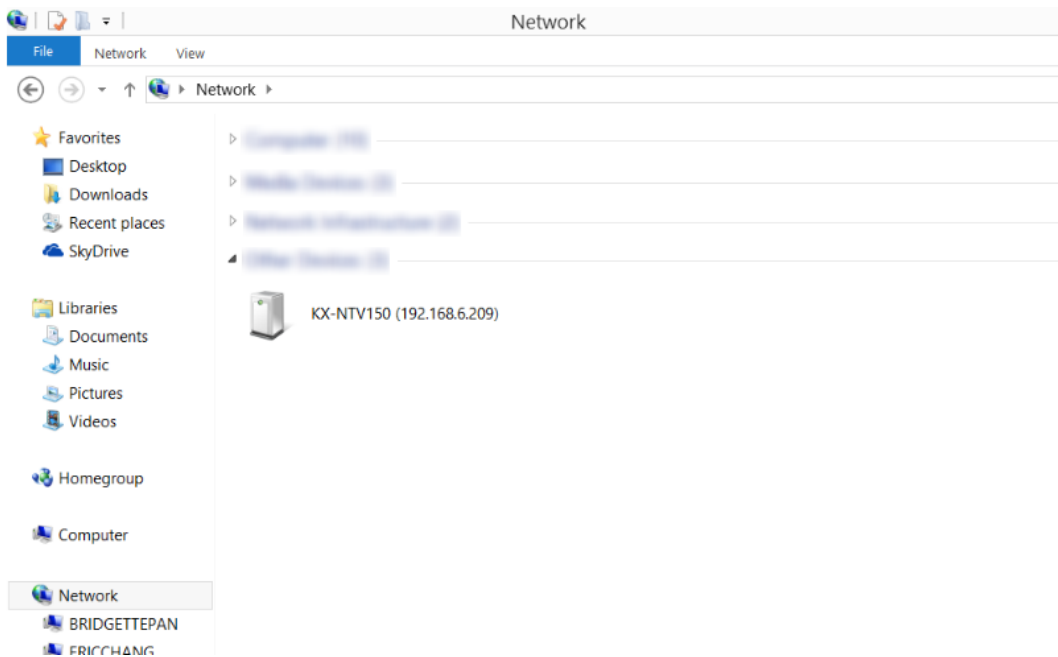

Enable UPnP port forwarding: UPnP port forwarding, or NAT traversal, automatically configures port mapping in a NAT router. To allow access from the Internet, select this option to allow the KX-NTV150/KX-NTV160 to automatically open ports on the router so that video streams can be delivered to the outside of a local network. In order to utilize this feature, you will first need to ensure that the UPnP port forwarding feature is supported and working on your router.

PPPoE (Point-to-point over Ethernet): Select this option to configure your KX-NTV150/KX-NTV160 to make it accessible from anywhere as long as there is an Internet connection. Note that to utilize this feature, it requires an account provided by your ISP.

Follow the steps below to acquire your KX-NTV150/KX-NTV160 public IP address.

1. Set up the KX-NTV150/KX-NTV160 on the LAN.
2. Go to Configuration → Event → Event settings → Add → Action → Add server (please refer to Add server on page 109) to add a new email or FTP server.
3. Go to Configuration → Event → Event settings → Add → Action → Add media (please refer to Add media on page 112).
Select System log so that you will receive the system log in TXT file format which contains the KX-NTV150/KX-NTV160 public IP address in your email or on the FTP server.
4. Go to Configuration → Network → General settings → Network type. Select PPPoE and enter the user name and password provided by your ISP. Click Save to enable the setting.
5. The KX-NTV150/KX-NTV160 will reboot.

- Disconnect the power to the KX-NTV150/KX-NTV160; remove it from the LAN environment.

Network type
Port

LAN
 PPPoE

User name:
 Password:
 Confirm password:

Note

- If the default ports are already used by other devices connected to the same router, the KX-NTV150/KX-NTV160 will select other ports for the KX-NTV150/KX-NTV160.
 - If UPnP is not supported by your router; you will see the following message:
Error: Router does not support UPnP port forwarding.
 - Steps to enable the UPnP user interface on your computer:
Note that you must log on to the computer as a system administrator to install the UPnP components.
- Go to Start, click Control Panel, and then click Network and Internet.

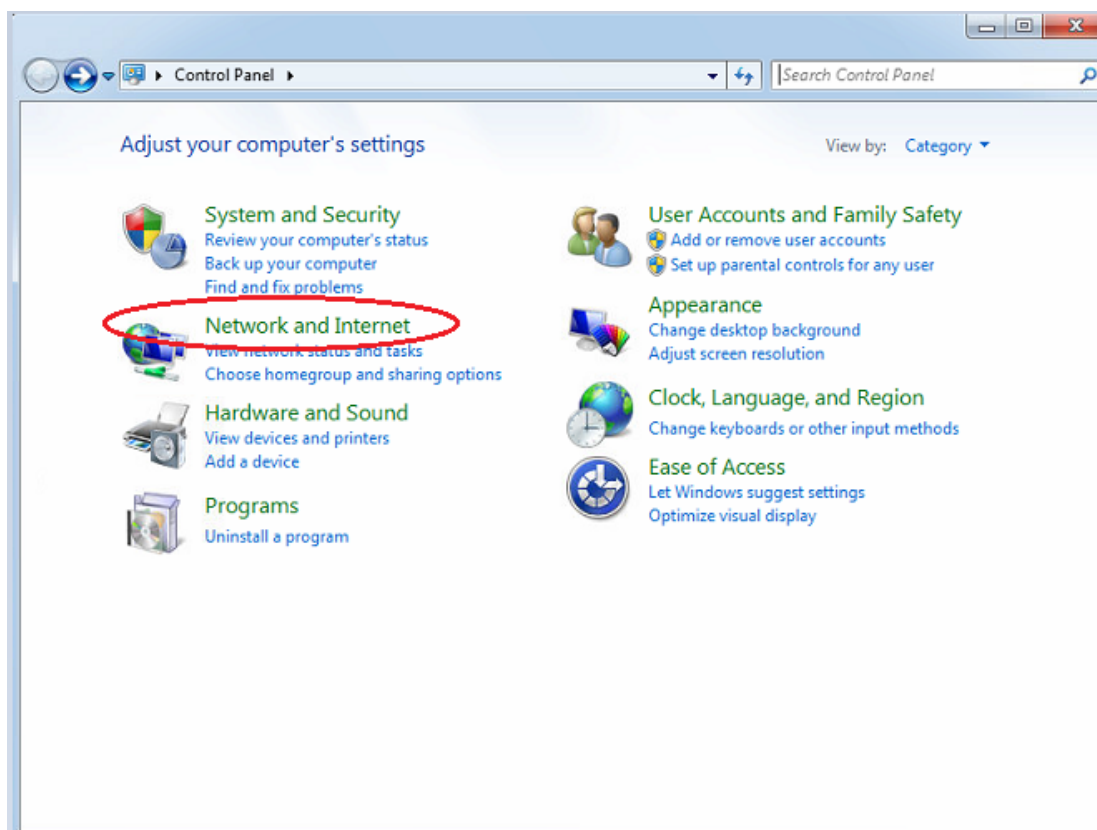

- Click Network and Sharing Center → Change advanced sharing settings.
- In Network Discovery, select Turn on network discovery.
- Click Save Change. UPnP is enabled.

- How does UPnP work?
UPnP networking technology provides automatic IP configuration and dynamic discovery of devices added to a network. Services and capabilities offered by networked devices, such as printing and file sharing, are available among each other without the need for cumbersome network configuration. In the case of KX-NTV150/KX-NTV160, you will see KX-NTV150/KX-NTV160 shortcuts under My Network Places.
- Enabling UPnP port forwarding allows the KX-NTV150/KX-NTV160 to open a secondary HTTP port on the router-not HTTP port-meaning that you have to add the secondary HTTP port number to the KX-NTV150/KX-NTV160 public address in order to access the KX-NTV150/KX-NTV160 from the Internet. For example, when the HTTP port is set to 80 and the secondary HTTP port is set to 8080, refer to the list below for the IP address of the KX-NTV150/KX-NTV160.

From the Internet	In LAN
http://203.67.124.123:8080	http://192.168.4.160 or http://192.168.4.160:8080

- If the PPPoE settings are incorrectly configured or the Internet access is not working, restore the KX-NTV150/KX-NTV160 to factory default; please refer to Restore on page 54 for details. After the KX-NTV150/KX-NTV160 is reset to factory default, it will be accessible on the LAN.

Port

Network type

Port

HTTPS port:

443

Two way audio port:

3454

FTP port:

21

HTTPS port: By default, the HTTPS port is set to 443. It can also be assigned to another port number between 1025 and 65535.

Two way audio port: By default, the two way audio port is set to 5060. Also, it can also be assigned to another port number between 1025 and 65535. Note that as JPEG only transmits a series of JPEG images to the client, to enable the two-way audio function, make sure the video mode is set to "H.264" on the Media → Video → Stream settings page and the media option is set to "Media → Video → Stream settings" on the Client settings page.

FTP port: The FTP server allows the user to save recorded video clips. You can utilize Panasonic's Installation Wizard to upgrade the firmware via FTP server. By default, the FTP port is set to 21. It also can be assigned to another port number between 1025 and 65535.

2.10.2 Streaming protocols

HTTP streaming

To utilize HTTP authentication, make sure that you have set a password for the KX-NTV150/KX-NTV160 first; please refer to Security → User accounts on page 92 for details.

Authentication: Depending on your network security requirements, the KX-NTV150/KX-NTV160 provides two types of security settings for an HTTP transaction: basic and digest.

If basic authentication is selected, the password is sent in plain text format and there can be potential risks of being intercepted. If digest authentication is selected, user credentials are encrypted using MD5 algorithm and thus provide better protection against unauthorized accesses.

HTTP port/Secondary HTTP port: By default, the HTTP port is set to 80 and the secondary HTTP port is set to 8080. They can also be assigned to another port number between 1025 and 65535. If the ports are incorrectly assigned, a warning message will be displayed.

To access the KX-NTV150/KX-NTV160 on the LAN, both the HTTP port and secondary HTTP port can be used to access the KX-NTV150/KX-NTV160. For example, when the HTTP port is set to 80 and the secondary HTTP port is set to 8080, refer to the list below for the KX-NTV150/KX-NTV160's IP address.

On the LAN

http://192.168.4.160 or http://192.168.4.160:8080

Access name for stream 1 (RTSP): This KX-NTV150/KX-NTV160 supports multiple streams simultaneously. Users can click Media → Video → Stream settings to set up the video quality of linked streams. For more information about how to set up the video quality, please refer to Stream settings on page 76.

When using Mozilla Firefox to access the KX-NTV150/KX-NTV160 and the video mode is set to JPEG, users will receive video comprised of continuous JPEG images. This technology, known as "server push", allows the KX-NTV150/KX-NTV160 to feed live pictures to Mozilla Firefox.

URL command: http://<ip address>:<http port>/video.mjpg

For example, when the Access name for stream:

1. Launch Mozilla Firefox.
2. Enter the above URL command in the address bar. Press Enter.

3. The JPEG images will be displayed in your web browser.

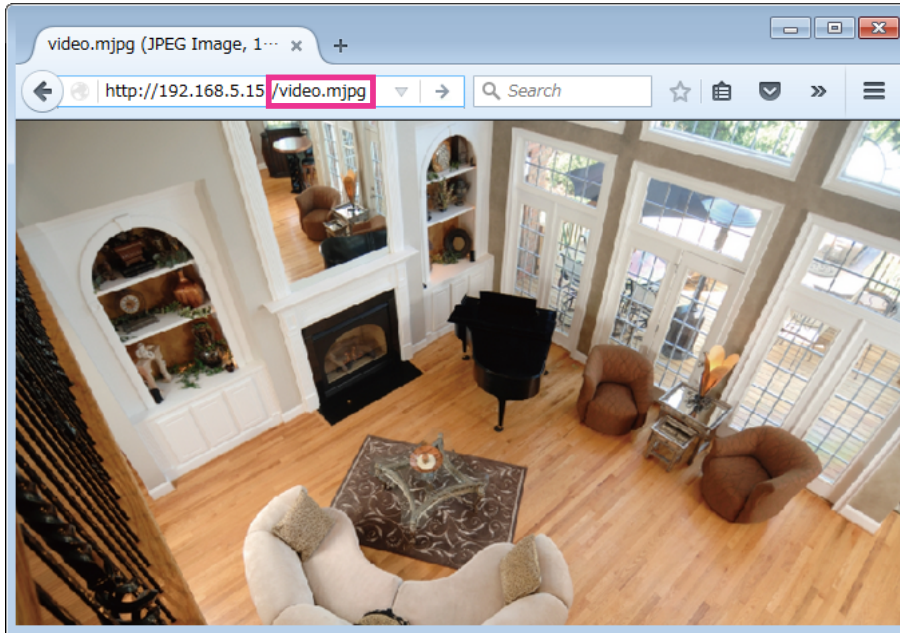

Note

- Microsoft Internet Explorer does not support server push technology; therefore, using `http://<ip address>:<http port>/video.mjpg` will fail to access the KX-NTV150/KX-NTV160.

RTSP streaming

To utilize RTSP streaming authentication, make sure that you have set a password for the KX-NTV150/KX-NTV160 first; please refer to Security → User accounts on page 92 for details.

HTTP streaming		RTSP streaming	
Authentication:	basic ▼		
Access name for stream 1:	live.sdp		
RTSP port:	554		
RTP port for video:	5556		
RTCP port for video:	5557		
RTP port for metadata:	6556		
RTCP port for metadata:	6557		
RTP port for audio:	5558		
RTCP port for audio:	5559		
✦ Multicast settings for stream 1			
Save			

Authentication: Depending on your network security requirements, the KX-NTV150/KX-NTV160 provides three types of security settings for streaming via RTSP protocol: disable, basic, and digest.

If basic authentication is selected, the password is sent in plain text format, but there can be potential risks of it being intercepted. If digest authentication is selected, user credentials are encrypted using MD5 algorithm, thus providing better protection against unauthorized access.

The availability of the RTSP streaming for the three authentication modes is listed in the following table:

	QuickTime player	Real Player
Disable	✓	✓
Basic	✓	✓
Digest	✓	×

Access name for stream 1: This KX-NTV150/KX-NTV160 supports multiple streams simultaneously.

If you want to use an RTSP player to access the KX-NTV150/KX-NTV160, you have to set the video mode to H.264 and use the following RTSP URL command to request transmission of the streaming data.

`rtsp://<ip address>:<rtsp port>/live.sdp`

For example, when the access name for stream 1 is set to live.sdp:

1. Launch an RTSP player.
2. Choose a file and then open a URL. A URL dialog box will pop up.
3. Type the above URL command in the text box.
4. The live video will be displayed in your player as shown below.

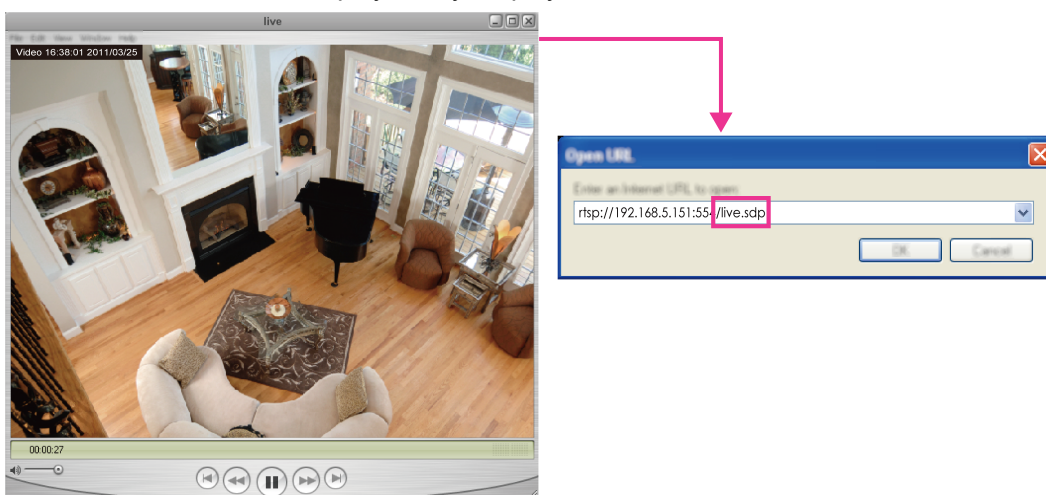

RTSP port/RTP port for video, audio/RTCP port for video, audio

- RTSP (Real-Time Streaming Protocol) controls the delivery of streaming media. By default, the port number is set to 554.
- The RTP (Real-time Transport Protocol) is used to deliver video and audio data to the clients. By default, the RTP port for video is set to 5556 and the RTP port for audio is set to 5558.
- The RTCP (Real-time Transport Control Protocol) allows the KX-NTV150/KX-NTV160 to transmit the data by monitoring the Internet traffic volume. By default, the RTCP port for video is set to 5557 and the RTCP port for audio is set to 5559.

The ports can be changed to values between 1025 and 65535. The RTP port must be an even number and the RTCP port is the RTP port number plus one, and thus is always an odd number. When the RTP port changes, the RTCP port will change accordingly.

If the RTP ports are incorrectly assigned, the following warning message will be displayed:



RTP video port must be from 1025 to 65535

Multicast settings for stream 1: Click the items to display the detailed configuration information. Select the Always multicast option to enable multicast for stream 1.

▼ Multicast settings for stream 1

Always multicast

Multicast group address:

Multicast video port:

Multicast RTCP video port:

Multicast metadata port:

Multicast RTCP metadata port:

Multicast audio port:

Multicast RTCP audio port:

Multicast TTL [1~255]:

Unicast video transmission delivers a stream through point-to-point transmission; multicast, on the other hand, sends a stream to the multicast group address and allows multiple clients to acquire the stream at the same time by requesting a copy from the multicast group address. Therefore, enabling multicast can effectively save Internet bandwidth.

The port numbers can be changed to values between 1025 and 65535. The multicast RTP port must be an even number and the multicast RTCP port number is the multicast RTP port number plus one, and thus is always odd. When the multicast RTP port changes, the multicast RTCP port will change accordingly. If the multicast RTP video ports are incorrectly assigned, a warning message will be displayed.

Multicast TTL [1-255]: The multicast TTL (Time To Live) is the value that tells the router the range a packet can be forwarded.

Initial TTL	Scope
0	Restricted to the same host
1	Restricted to the same sub network
32	Restricted to the same site
64	Restricted to the same region
128	Restricted to the same continent
225	Unrestricted in scope

2.10.3 DDNS

This section explains how to configure the dynamic domain name service for the KX-NTV150/KX-NTV160. DDNS is a service that allows your KX-NTV150/KX-NTV160, especially when assigned with a dynamic IP address, to have a fixed host and domain name.

Manual setup

DDNS: Dynamic domain name service

Manual setup

Enable DDNS

Provider:

Host name:

User name:

Password:

Enable DDNS: Select this option to enable the DDNS setting.

Provider: Select a DDNS provider from the provider drop-down list.

We offer other DDNS providers, such as DynDNS.org (Dynamic) and DynDNS.org (Custom).

Note that before utilizing this function; please apply for a dynamic domain account first.

2.10.4 QoS (Quality of Service)

Quality of Service refers to a resource reservation control mechanism, which guarantees a certain quality to different services on the network. Quality of service guarantees are important if the network capacity is insufficient, especially for real-time streaming multimedia applications. Quality can be defined as, for instance, a maintained level of bit rate, low latency, no packet dropping, etc.

The following are the main benefits of a QoS-aware network:

- The ability to prioritize traffic and guarantee a certain level of performance to the data flow.
- The ability to control the amount of bandwidth each application may use, and thus provide higher reliability and stability on the network.

Requirements for QoS

To utilize QoS in a network environment, the following requirements must be met:

- All network switches and routers in the network must include support for QoS.
- The network video devices used in the network must be QoS-enabled.

QoS models

CoS (the VLAN 802.1p model)

IEEE802.1p defines a QoS model at OSI Layer 2 (Data Link Layer), which is called CoS, Class of Service. It adds a 3-bit value to the VLAN MAC header, which indicates the frame priority level from 0 (lowest) to 7 (highest). The priority is set up on the network switches, which then use different queuing disciplines to forward the packets.

Below is the setting column for CoS. Enter the VLAN ID of your switch (0~4095) and choose the priority for each application (0~7).

CoS

Enable CoS

VLAN ID:

Live video: ▼

Live audio: ▼

Event/Alarm: ▼

Management: ▼

Note

- A VLAN Switch (802.1p) is required. The web browsing may fail if the CoS setting is incorrect.
- Class of Service technologies do not guarantee a level of service in terms of bandwidth and delivery time; they offer a "best-effort." Users can think of CoS as "coarsely-grained" traffic control and QoS as "finely-grained" traffic control.
- Although CoS is simple to manage; it lacks scalability and does not offer end-to-end guarantees since it is based on L2 protocol.

QoS/DSCP (the DiffServ model)

DSCP-ECN defines QoS at Layer 3 (Network Layer). The Differentiated Services (DiffServ) model is based on packet marking and router queuing disciplines. The marking is done by adding a field to the IP header, called the DSCP (Differentiated Services Codepoint). This is a 6-bit field that provides 64 different class IDs. It gives an indication of how a given packet is to be forwarded, known as the Per Hop Behavior (PHB). The PHB describes a particular service level in terms of bandwidth, queuing theory, and dropping (discarding the packet) decisions. Routers at each network node classify packets according to their DSCP value and give them a particular forwarding treatment; for example, how much bandwidth to reserve for it.

Below are the setting options of DSCP (DiffServ Codepoint). Specify the DSCP value for each application (0~63).

QoS/DSCP

Enable QoS/DSCP

Live video:

Live audio:

Event/Alarm:

Management:

2.10.5 SNMP (Simple Network Management Protocol)

This section explains how to use the SNMP on the KX-NTV150/KX-NTV160. The Simple Network Management Protocol is an application layer protocol that facilitates the exchange of management information between network devices. It helps network administrators to remotely manage network devices and find, solve network problems with ease.

The SNMP consists of the following three key components:

1. **Manager:** Network-management station (NMS), a server which executes applications that monitor and control managed devices.
2. **Agent:** A network-management software module on a managed device which transfers the status of managed devices to the NMS.
3. **Managed device:** A network node on a managed network. For example: routers, switches, bridges, hubs, computer hosts, printers, IP telephones, network cameras, web server, and database.

Before configuring SNMP settings on this page, please enable your NMS first.

SNMP Configuration

Enable SNMPv1, SNMPv2c

Select this option and enter the names of Read/Write community and Read Only community according to your NMS settings.

Enable SNMPv1, SNMPv2c

Read/Write community:

Read only community:

Enable SNMPv3

This option contains cryptographic security, a higher security level, which allows you to set the Authentication password and the Encryption password.

- **Read/Write security name:** According to your NMS settings, choose Read/Write or Read Only and enter the community name.
- **Authentication type:** Select MD5 or SHA as the authentication method.
- **Authentication Password:** Enter the password for authentication (at least 8 characters).
- **Encryption password:** Enter a password for encryption (at least 8 characters).

Enable SNMPv3

Read/Write security name:

Authentication type:

Authentication Password:

Encryption password:

Read only security name:

Authentication type:

Authentication Password:

Encryption password:

2.11 Wireless

2.11.1 WLAN (KX-NTV150 only)

Enable WiFi

WLAN configuration

SSID	<input type="text" value="Buffalo-G-CBF0"/>
Wireless mode	<input type="text" value="Infrastructure"/>
Security	<input type="text" value="WPA2-PSK"/>
pre-shared key	<input type="text" value="12345678"/>

Enable WiFi (default checked):

If connect camera with PoE (Power over Ethernet) cable, camera directly connects to LAN. If connected only with AC adaptor power and without a LAN cable, the camera connects to WLAN. However if this setting is unchecked, camera cannot connect to WLAN in all situations.

Although the wireless connection is made before you can access the camera's configuration page, you can enter the WLAN settings if configuration change should be made, e.g., connecting to a different AP (Access Point).

Below are more information about encryption and other wireless-related settings.

SSID (Service Set Identifier): This is the name that identifies a wireless network. Access Points and wireless clients attempting to connect to a specific WLAN (Wireless Local Area Network) must use the same SSID. The default setting is "default".

Note

- The maximum length for an SSID is 32 single-byte characters and cannot consist of ", <, >, or blank spaces. Note that the SSID is case-sensitive.

Wireless mode: Select the infrastructure mode to connect to wireless AP. Select Ad-hoc mode to communicate with the camera without using an AP or wireless router.

Security: Select the data encrypt method. There are four types, including: none, WEP, WPA-PSK, and WPA2-PSK.

1. None: No data encryption.

2. WEP (Wired Equivalent Privacy): This allows communication only with other devices with identical WEP settings.

Enable WiFi

WLAN configuration

SSID	<input type="text" value="Buffalo-G-CBF0"/>
Wireless mode	<input type="text" value="Infrastructure"/>
Security	<input type="text" value="WEP"/>
Authentication mode	<input type="text" value="Open"/>
Key length	<input type="text" value="64 bits"/>
Key format	<input type="text" value="Hex"/>
Default key	<input type="radio"/> Network key <input type="radio"/> <input type="radio"/> <input type="radio"/>
	<input type="text" value="0000000000"/>
	<input type="text" value="0000000000"/>
	<input type="text" value="0000000000"/>
	<input type="text" value="0000000000"/>

- Authentication mode: Choose one of the following modes. The default setting is "Open".
Open: Communicates the key across the network.
Shared: Allows communication only with other devices with identical WEP settings.
- Key length: The administrator can set the key length to 64 or 128 bits.
The default setting is "64 bits".
- Key format: Hexadecimal or ASCII. The fault setting is "HEX".
HEX digits consist of the numbers 0~9 and the letters A-F.
- Network key: Enter a key in either hexadecimal or ASCII format.
You can select different key lengths, the acceptable input lengths are as follows:
64-bit key length: 10 Hex digits or 5 characters.
128-bit key length: 26 Hex digits or 13 characters.

3. WPA-PSK: Use WPA® (Wi-Fi Protected Access) pre-shared key.

Enable WiFi

WLAN configuration

SSID	<input type="text" value="Buffalo-G-CBF0"/>
Wireless mode	<input type="text" value="Infrastructure"/>
Security	<input type="text" value="WPA-PSK"/>
pre-shared key	<input type="text" value="12345678"/>

- **pre-shared key:** Enter a key in ASCII format. The length of the key can be between 8 to 63 characters.
4. WPA2-PSK: Use WPA2 pre-shared key.
We recommend to use WPA-PSK/WPA2-PSK because they are more secure.
- After wireless configurations are completed, click Save and the KX-NTV150 will reboot. Wait for the live image to be reloaded to your browser. You have to unplug the power and Ethernet cables from the KX-NTV150; then re-plug the power cable to the KX-NTV150. The KX-NTV150 will switch to wireless mode.
 - Some invalid settings may cause the system to fail to respond. Change the configuration settings only if necessary and consult with your network supervisor or experienced users for correct settings. Once the system has lost contact, please refer to Maintenance on page 58 for reset and restore procedures.

2.12 Security

2.12.1 User accounts

This section explains how to enable password protection and create multiple accounts.

Root password

Root password | **Privilege management** | **Account management**

Root password:	<input type="password" value="....."/>	<input type="button" value="Save"/>
Confirm root password:	<input type="password" value="....."/>	

The administrator account name is "root", which is permanent and cannot be deleted. If you want to add more accounts in the Manage User column, please apply the password for the "root" account first.

1. Type the password identically in both text boxes, and then click Save to enable password protection.
2. A window will be prompted for authentication; type the correct user's name and password in their respective fields to access the KX-NTV150/KX-NTV160.

Privilege management

Digital output & PTZ control: You can modify the management privilege for operators or viewers. Select or deselect the checkboxes, then click Save to enable the settings. If you give Viewer the privilege, Operators will also have the ability to control the KX-NTV150/KX-NTV160 through the main page.

Allow anonymous viewing: If you check this item, any client can access the live stream via a video streaming player (for example, QuickTime player) without entering a User ID and Password. Once you have enabled this setting, users can also access the live view by entering the home view page IP address and without entering the account name and password.

*If users try to change the settings, the camera will ask them to log in with the administrator account and password.

Account management

Administrators can add up to 20 user accounts.

1. Input the new user's name and password.
2. Select the privilege level for the new user account. Click Add to enable the setting.

Access rights are sorted by user privilege (Administrator, Operator, and Viewer). Only administrators can access the Configuration page.

Although operators cannot access the Configuration page, they can use the URL Commands to get and set the value of parameters. Viewer access only the main page for live viewing.

Here you also can change a user's access rights or delete user accounts.

1. Select an existing account to modify.
2. Make necessary changes and click Update or Delete to enable the setting.

2.12.2 HTTPS (Hypertext Transfer Protocol over SSL)

This section explains how to enable authentication and encrypted communication over SSL (Secure Socket Layer). It helps protect streaming data transmission over the Internet on higher security level.

Enable HTTPS

Check this item to enable HTTPS communication, then select a connection option: "HTTP & HTTPS" or "HTTPS only". Note that you have to create and install a certificate first before clicking the Save button.

The screenshot shows the 'HTTPS' configuration section. At the top, 'Enable HTTPS secure connection' is checked. Below it, the 'Mode' is set to 'HTTP & HTTPS' with a radio button, while 'HTTPS only' is unselected.

Create and Install Certificate Method

Before using HTTPS for communication with the KX-NTV150/KX-NTV160, a Certificate must be created first. There are three ways to create and install a certificate:

Create self-signed certificate

1. Select this option from a pull-down menu.
2. In the first column, select Enable HTTPS secure connection, and then select a connection option: "HTTP & HTTPS" or "HTTPS only".
3. Click Create certificate to generate a certificate.

The screenshot shows the 'Certificate information' form. A dialog box is overlaid on the form, displaying the message 'Please wait while the certificate is being generated...'. The form fields include: Status (Not installed), Method (Certificate), Country, State or province, Locality (Asia), Organization (Panasonic Corp.), Organization unit (Panasonic Corp.), Common name (www.panasonic.com), and Validity (3650 days). A 'Create certificate' button is visible at the bottom right of the form.

- The Certificate information will automatically be displayed as shown below. You can click Certificate properties to view detailed information about the certificate.

✦ Certificate:

Certificate information	
Status:	Active
Method:	Create self-signed certificate
Country:	JP
State or province:	Asia
Locality:	Asia
Organization:	Panasonic Corp.
Organization unit:	Panasonic Corp.
Common name:	www.panasonic.com

[Certificate properties](#)

- Click Save to preserve your configuration and your current session with the KX-NTV150/KX-NTV160 will change to the encrypted connection.
- If your web session does not automatically change to an encrypted HTTPS session, click Home to return to the main page. Change the URL address from "http://" to "https://" in the address bar and press Enter on your keyboard. Some security dialogs may be displayed. Follow the displayed instructions to enable HTTPS.

Request and install certificates

- Select the option from the Method pull-down menu.

- 2. Click Create certificate to proceed.

▼ Certificate:

Certificate information

Status:	Not installed
Method:	Create self-signed certificate
Country:	JP
State or province:	Asia
Locality:	Asia
Organization:	Panasonic Corp.
Organization unit:	Panasonic Corp.
Common name:	www.panasonic.com
Validity:	3650 days

Create certificate

- 3. The Certificate information will automatically be displayed in the third column as shown below. You can click Property to see detailed information about the certificate.

Certificate properties

Certificate	
Version	3 (0x2)
Serial Number	aa:00:02:d1:3b:64:28
Signature Algorithm	sha1WithRSAEncryption
Issuer	C=JP, ST=Asia, L=Asia, O=Panasonic Corp.
Validity	
Not Valid Before	Jan 1 00:21:28 2000 GMT
Not Valid After	Dec 29 00:21:28 2009 GMT
Subject	C=JP, ST=Asia, L=Asia, O=Panasonic Corp.
Subject Public Key Info	
Public Key Algorithm	rsaEncryption
RSA Public Key (2048 bit)	
Public-Key: (2048 bit)	
Modulus:	00:f7:35:e9:67:41:48:66:eb:cf:09:9c:1d:42:62:7e:42:23:c4:35:5b:72:e4:4e:a4:fe:68:5f:95:85:2a:44:23:62:09:af:72:cd:1c:ad:ed:c6:3c:07:60:b1:33:54:99:08:4e:06:02:6e:64:46:34:51:71:ce:a2:a0:f6:ff:66:64:d6:31:42:29:95:08:b9:3d:3d:32:97:ee:49:67:db:2c:81:d2:ce:12:f1:20:ba:d7:e3:25:be:d7:ef:6b:28:f8:74

4. Copy the contents of the Certificate request (in PEM format). Use the contents to apply for a third-party certification authority such as Symantec VeriSign. Wait for the certificate authority to issue an SSL certificate; search for the issued certificate, and then upload it to finish the process.

Note

- How do I cancel the HTTPS settings?
1. Click on the Remove certificate button.

▼ Certificate:

Certificate information	
Status:	Active
Method:	Create self-signed certificate
Country:	JP
State or province:	Asia
Locality:	Asia
Organization:	Panasonic Corp.
Organization unit:	Panasonic Corp.
Common name:	www.panasonic.com

[Certificate properties](#)

2. If you are currently running a secure connection, the webpage will redirect to a non-HTTPS page automatically.

2.12.3 Access List

This section explains how to control access permission by verifying the client PC's IP address.

General settings

General settings

Maximum number of concurrent streaming:

Maximum number of concurrent streaming connection(s) limited to: Simultaneous live viewing for 1-10 clients (only can restrict stream1 for RTSP). The default value is 10. If you modify the value and click Save, all current connections will be disconnected and automatically attempt to re-link (Internet Explorer or QuickTime Player).

Connection management: Click this button to display the connection status window showing a list of the current connections. For example:

	IP address	Elapsed time	User ID
<input type="checkbox"/>	192.168.6.136	00:00:04	

Note that only the consoles that are currently displaying live streaming will be listed in the management list.

- **IP address:** Current connections to the KX-NTV150/KX-NTV160.
- **Elapsed time:** How much time the client has been at the webpage.
- **User ID:** If the administrator has set a password for the webpage, the clients have to enter a user name and password to access the live video. The user name will be displayed in the User ID column. If the administrator allows clients to link to the webpage without a user name and password, the User ID column will be empty.

There are some situations that allow clients access to the live video without a user name and password:

1. The administrator does not set up a root password. For more information about how to set up a root password and manage user accounts, please refer to Security → User accounts on page 92.
 2. The administrator has set up a root password, but set RTSP Authentication to "disable". For more information about RTSP Authentication, please refer to RTSP Streaming on page 84.
 3. The administrator has set up a root password, but allows anonymous viewing. For more information about Allow anonymous viewing, please refer to page 93.
- **Refresh:** Click this button to refresh all current connections.
 - **Add to deny list:** You can select entries from the Connection Status list and add them to the Deny List to deny access. Please note that those checked connections will only be disconnected temporarily and will automatically try to re-link again (via Internet Explorer or QuickTime Player). If you want to enable the denied list, please check Enable access list filtering and click Save in the first column.
 - **Disconnect:** If you want to break off the current connections, please select them and click this button. Please note that those checked connections will only be disconnected temporarily and will automatically try to re-link again (Internet Explorer or QuickTime Player).

Filter

Enable access list filtering: Check this item and click Save if you want to enable the access list filtering function.

Filter type: Select Allow or Deny as the filter type. If you choose Allow, only those clients whose IP addresses are on the Access List below can access the KX-NTV150/KX-NTV160, and the others cannot access. On the

contrary, if you choose Deny, those clients whose IP addresses are on the Access List below will not be allowed to access the KX-NTV150/KX-NTV160, and the others can access.

Filter

Enable access list filtering

Filter type: Allow Deny

IPv4 access list

Then you can add a rule to the following Access List.
Please select the Enable access list filtering checkbox for your configuration to take effect.
There are three types of rules:

Single: This rule allows the user to add an IP address to the Allowed/Denied list.

For example:

Filter address

Rule:

IP address:

Network: This rule allows the user to assign a network address and corresponding subnet mask to the Allow/Deny List. The address and network mask are written in CIDR format.

For example:

Filter address

Rule:

Network address / Network mask: /

IP address range 192.168.2.x will be blocked

Range: This rule allows the user to assign a range of IP addresses to the Allow/Deny List.

Note

- This rule is only applied to IPv4.

For example:

Filter address

Rule: Range

IP address - IP address: -

Administrator IP address

Always allow the IP address to access this device: You can check this item and add the Administrator IP address in this field to make sure the Administrator can always connect to the device.

Administrator IP address

Always allow the IP address to access this device:

2.12.4 IEEE 802.1X

Enable this function if your network environment uses IEEE 802.1x, which is a port-based network access control. The network devices, intermediary switch/access point/hub, and RADIUS server must support and enable 802.1x settings.

The 802.1x standard is designed to enhance the security of local area networks, which provides authentication to network devices (clients) attached to a network port (wired or wireless). If all certificates between client and server are verified, a point-to-point connection will be enabled; if authentication fails, access on that port will be prohibited. 802.1x utilizes an existing protocol, the Extensible Authentication Protocol (EAP), to facilitate communication.

The components of a protected network with 802.1x authentication:

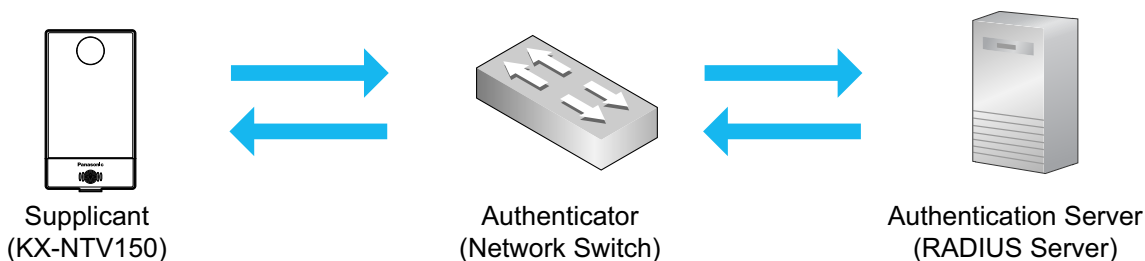

1. Supplicant: A client end user (KX-NTV150/KX-NTV160), which requests authentication.
2. Authenticator (an access point or a switch): A "go between" which restricts unauthorized end users from communicating with the authentication server.
3. Authentication server (usually a RADIUS server): Checks the client certificate and decides whether to accept the end user's access request.

KX-NTV150/KX-NTV160 support two types of EAP methods to perform authentication: EAPPEAP and EAP-TLS.

Please follow the steps below to enable 802.1x settings:

1. Before connecting the KX-NTV150/KX-NTV160 to the protected network with 802.1x, please apply a digital certificate from a Certificate Authority (i.e., your network administrator) which can be validated by a RADIUS server.
2. Connect the KX-NTV150/KX-NTV160 to a PC or notebook outside of the protected LAN. Open the configuration page of the KX-NTV150/KX-NTV160 as shown below. Select EAP-PEAP or EAP-TLS as the EAP method. In the following blanks, enter your ID and password issued by the CA, then upload related certificate(s).

IEEE 802.1x

Enable IEEE 802.1x

EAP method:

Identity:

Password:

CA certificate:

Status: no file

IEEE 802.1x

Enable IEEE 802.1x

EAP method:

Identity:

Private key password:

CA certificate:

Status: no file

Client certificate:

Status: no file

Client private key:

Status: no file

3. When all settings are complete, move the KX-NTV150/KX-NTV160 to the protected LAN by connecting it to an 802.1x enabled switch. The devices will then start the authentication automatically.

Note

- The authentication process for 802.1x:
 1. The Certificate Authority (CA) provides the required signed certificates to the KX-NTV150/KX-NTV160 (the supplicant) and the RADIUS Server (the authentication server).
 2. KX-NTV150/KX-NTV160 requests access to the protected LAN using 802.1X via a switch (the authenticator). The client offers its identity and client certificate, which is then forwarded by the switch to the RADIUS Server, which uses an algorithm to authenticate the KX-NTV150/KX-NTV160 and returns an acceptance or rejection back to the switch.
 3. The switch also forwards the RADIUS Server's certificate to the KX-NTV150/KX-NTV160.

4. Assuming all certificates are validated, the switch then changes the state of the KX-NTV150/ KX-NTV160 to authorized and access is allowed to the protected network via a pre-configured port.

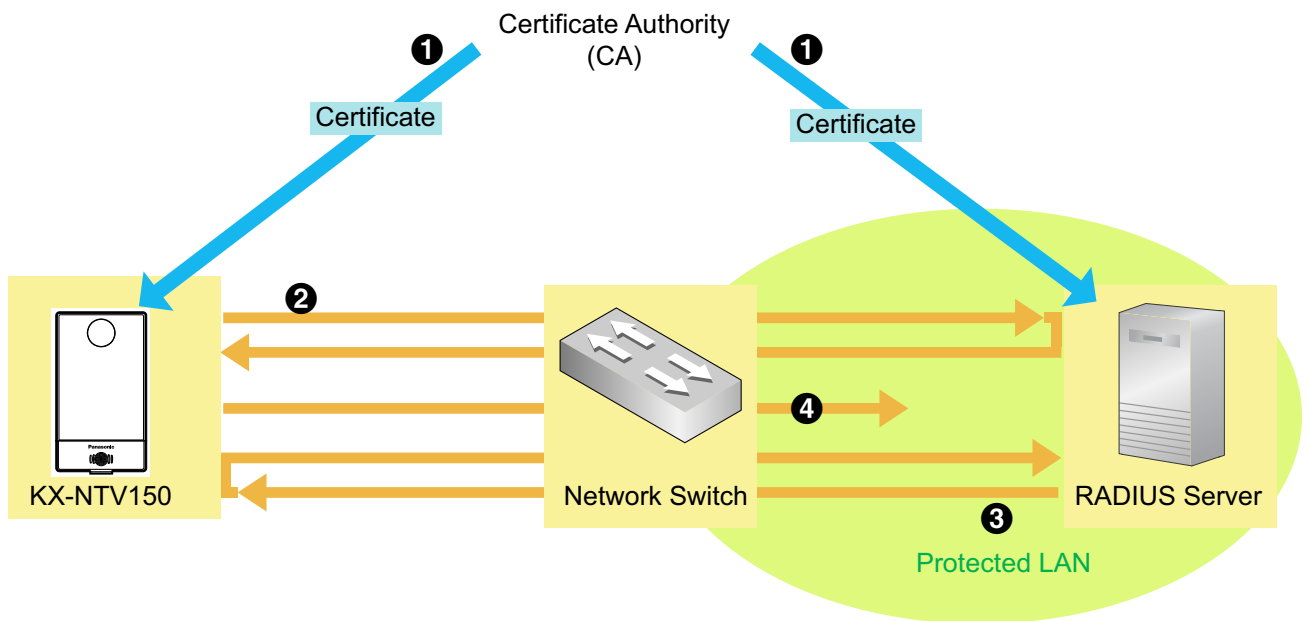

2.13 PTZ

2.13.1 PTZ settings

This section explains how to control the Pan/Tilt/Zoom operations of the KX-NTV150/KX-NTV160.
Digital PTZ Operation (E-PTZ Operation)

The e-PTZ control settings section will be displayed as shown below:

Digital

(TPC-V) 2016/01/15 17:08:56



Zoom
 Pan speed:
 Tilt speed:
 Zoom speed:
 Auto pan/patrol speed:
 Go to: -- Select one --

Home location settings

Preset and patrol settings

Name:

Select Preset Locations for Patrol

<input checked="" type="checkbox"/> User preset locations	<input type="checkbox"/> Patrol locations	Dwell time (sec)
<input checked="" type="checkbox"/> upper left	<input type="checkbox"/> upper left	<input type="text" value="5"/>
<input checked="" type="checkbox"/> lower left	<input type="checkbox"/> lower left	<input type="text" value="5"/>
<input checked="" type="checkbox"/> center	<input type="checkbox"/> center	<input type="text" value="5"/>
<input checked="" type="checkbox"/> upper right	<input type="checkbox"/> upper right	<input type="text" value="5"/>
<input checked="" type="checkbox"/> lower right	<input type="checkbox"/> lower right	<input type="text" value="5"/>

Misc settings

Zoom factor display

Auto pan/patrol speed: Select the speed from 1-5 (slow/fast) to set up the Auto pan/patrol speed control.

Zoom factor display: Enable for users who can see the ratio of zoom in/zoom out.

Home location settings: You can set or restore the home position.

When completed with the e-PTZ settings, click Save to enable the settings on this page.

Home page in E-PTZ Mode

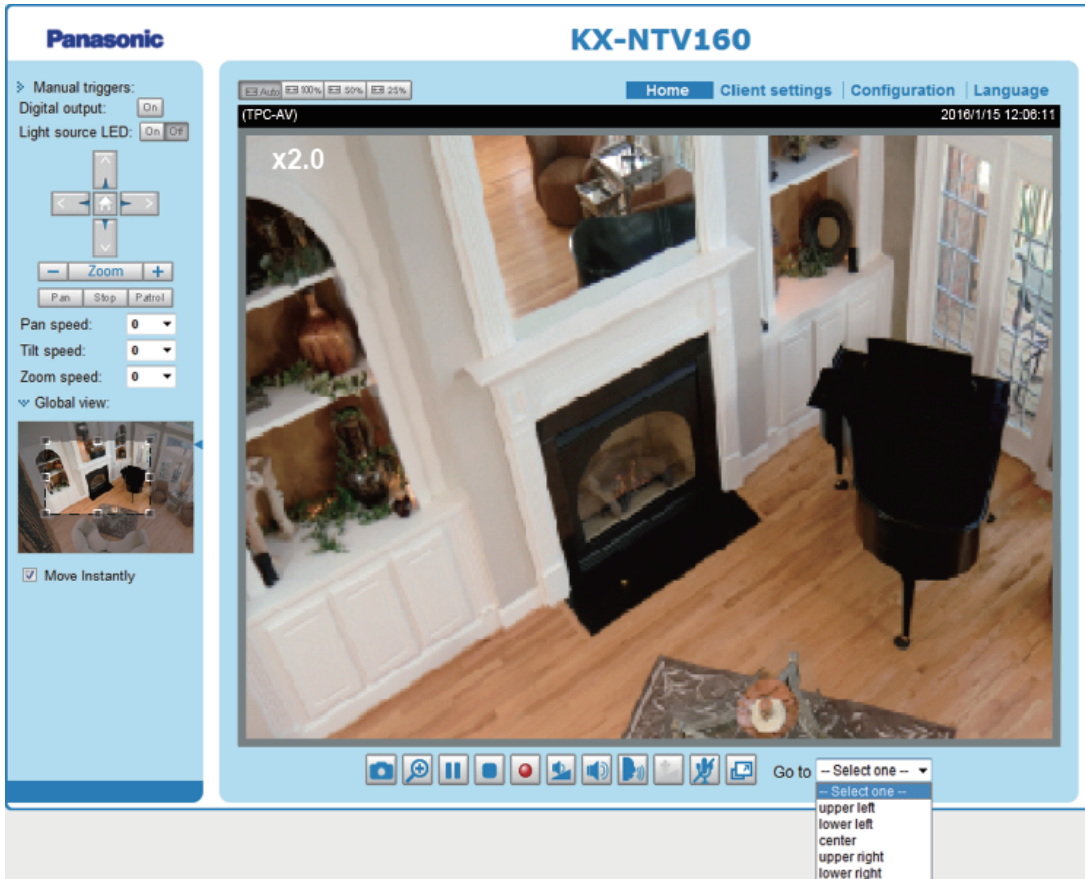

- The e-Preset Positions will also be displayed on the home page. Select one from the drop-down list and the view area of the KX-NTV150/KX-NTV160 will move to the selected e-preset position.
- If you have configured different e-preset positions for different streams, you can select one of the video streams to display its separate e-preset positions.

Global View

In addition to using the e-PTZ control panel, you can also use the mouse to drag or resize the floating frame to pan/tilt/zoom the viewing region. The live view window will also move to the viewing region accordingly.

Moving Instantly

If you check this item, the live view window will switch to the new viewing region instantly after you move the floating frame.

Click on Image

The e-PTZ function also supports "Click on Image". When you click on any point of the Global View Window or on the Live View Window, the viewing region will also move to that point.

Note that the "Click on Image" function only applies when you have configured a smaller "Region of Interest" out of the maximum output frame, e.g., an 1024x768 region from the 1280x960 maximum frame size of the KX-NTV150/KX-NTV160. This enables you to travel to other unrevealed areas within the maximum frame size.

Patrol settings

You can select some preset positions for the KX-NTV150/KX-NTV160 to patrol.

Please follow the steps below to set up a patrol schedule:

- 1 Select the preset locations on the list, and click.
- 2 The selected preset locations will be displayed on the Patrol locations list.
- 3 Set the Dwelling time for the preset location during auto patrol.
- 4 If you want to delete a preset location from the Patrol locations list, select it and click Remove.
- 5 Select a location and click to rearrange the patrol order.
- 6 Select patrol locations you want to save in the list and click Save to enable the patrol settings.
- 7 To implement the patrol schedule, please go to homepage and click on Patrol button.

Digital

(TPC-V)
2016/01/15 17:08:56



▲

◀ Home ▶

▼

- Zoom +

Pan speed:

Tilt speed:

Zoom speed:

Auto pan/patrol speed:

Go to: -- Select one --

Home location settings

Set current position as home
Restore home position to default

Preset and patrol settings

Name: Add

Select Preset Locations for Patrol

1 **User preset locations**

- upper left
- lower left
- center
- upper right
- lower right

Remove
More

Patrol locations **3** Dwell time (sec)

<input type="checkbox"/> upper left	5
<input type="checkbox"/> lower left	5
<input type="checkbox"/> center	5
<input type="checkbox"/> upper right	5
<input type="checkbox"/> lower right	5

4 Remove
5 ▲ ▼
More

Misc settings

Zoom factor display

6 Save

- The Preset Positions will also be displayed on the home page. Select one from the Go to drop-down list, and the KX-NTV150/KX-NTV160 will move to the selected preset position.
- Click Patrol: The KX-NTV150/KX-NTV160 will patrol along the selected positions repeatedly.

2.14 Event

2.14.1 Event settings

This section explains how to configure the KX-NTV150/KX-NTV160 to respond to particular situations (event). A typical application is that when a motion is detected, the KX-NTV150/KX-NTV160 sends buffered images to an FTP server or e-mail address as notifications. Click on Help, there is an illustration shown in the pop-up window explaining that an event can be triggered by many sources, such as motion detection or external digital input devices. When an event is triggered, you can specify what type of action that will be performed. You can configure the KX-NTV150/KX-NTV160 to send snapshots or videos to your email address or FTP site.



Event

To set an event with recorded video or snapshots, it is necessary to configure the server and media settings so that the KX-NTV150/KX-NTV160 will know what action to take (such as which server to send the media files to) when a trigger is activated. An event is an action initiated by a user-defined trigger source. In the Event column, click Add to open the event settings window. Here you can arrange three elements: Schedule, Trigger, and Action to set an event. A total of 3 event settings can be configured.

Event name:

Enable this event

Priority:

Detect next event after second(s).

Event schedule

Sun Mon Tue Wed Thu Fri Sat

Time

Always

From to [hh:mm]

1. Schedule

2. Trigger

3. Action

- **Event name:** Enter a name for the event setting.
- **Enable this event:** Select this option to enable the event setting.
- **Priority:** Select the relative importance of this event (High, Normal, or Low). Events with a higher priority setting will be executed first.

- **Detect next event after:** Enter the duration in seconds to pause motion detection after a motion is detected. This can prevent event-related actions to be too frequently performed. When the "System time" is synchronized with NTP server, the timer of "Detect next event" will be reset.

Note

- Periodically is not applied for the setting.
1. Schedule
Specify the period of them during which the event trigger will take place. Please select the days of the week and the time in a day (in a 24-hr time format) for the event triggering schedule.
 2. Trigger
This is the cause or stimulus which defines when to trigger the KX-NTV150/KX-NTV160. The trigger source can be configured to use the built-in motion detection mechanism or external digital input devices of the KX-NTV150/KX-NTV160.
There are several choices of trigger sources as shown on next page. Select the item to display the detailed configuration options.

Video motion detection

This option makes use of the built-in motion detection mechanism as a trigger source. To enable this function, you need to configure a Motion detection Window first. For more information, please refer to Motion detection on page 116 for details.

Video motion detection

Normal: Motion1

Profile:

Note: Please configure [Motion detection](#) first

Periodically

This option allows the KX-NTV150/KX-NTV160 to trigger periodically for every other defined minute. Up to 999 minutes are allowed.

Periodically

Trigger every other minute(s)

Digital input

This option allows the KX-NTV150/KX-NTV160 to use an external digital input device or sensor as a trigger source. Depending on your application, there are many choices of digital input devices on the market which helps to detect changes in temperature, vibration, sound, and light, etc.

System boot

This option triggers the KX-NTV150/KX-NTV160 when the power to the KX-NTV150/KX-NTV160 is disconnected.

Recording notify

This option allows the KX-NTV150/KX-NTV160 to trigger when the recording disk is full or when recording starts to rewrite older data.

Voice detection

A preset threshold can be configured with an external microphone as the trigger to system event. The triggering condition can be an input exceeding or falling below a threshold. Voice detection can take place as a complement to motion detection or as a method to detect activities not covered by the view of the KX-NTV150/KX-NTV160.

Voice detection

Normal: Trigger event when detected audio rises above Alarm level

Profile: Trigger event when detected audio rises above Alarm level

Note: Please configure [Voice detection](#) first

Once you have a preset audio alarm level, you can define the triggering condition either as an audio input rises above or falls below the alarm level.

Camera tampering detection

This option allows the KX-NTV150/KX-NTV160 to trigger when the KX-NTV150/KX-NTV160 detects that is being tampered with. To enable this function, you need to configure the Tampering Detection option first. Please refer to page 120 for detailed information.

Camera tampering detection

Tampering detection Too dark Too bright Too blurry

Note: Please configure [Camera tampering detection](#) first

Manual triggers

This option allows users to enable event triggers manually by clicking the on/off button on the homepage. Please configure 1 to 3 associated events before using this function.

Manual triggers

1 2 3

3. Action

Define the actions to be performed by the KX-NTV150/KX-NTV160 when a trigger is activated.

The 'Action' configuration window contains the following elements:

- Table with columns: Server, Media, Extra parameter
- SIP outgoing
- NAS Create folders by date time and hour automatically [View](#)
-
-

Trigger digital output for seconds

Select this option to turn on the external digital output device when a trigger is activated. Specify the length of the trigger interval in the text box.

Add server

To set an event that will be recorded in videos or snapshots, it is necessary to configure the server and media settings so that the KX-NTV150/KX-NTV160 will know what action to take (such as which server to send the media files to) when a trigger is activated. Click Add server to open the server setting window. You can specify where the notification messages are sent when a trigger is activated. A total of 5 server settings can be configured.

There are five choices of server types available: Email, FTP, HTTP, Network storage, and "SIP Outgoing". Select the item to display the detailed configuration options. You can configure either one or all of them.

Server name:

Server type

Email

Sender email address:

Recipient email address:

Server address:

User name:

Password:

Server port

This server requires a secure connection (SSL)

FTP

HTTP

Network storage

SIP Outgoing

Server type - Email

Select to send the media files via email when a trigger is activated.

- **Server name:** Enter a name for the server setting.
- **Sender email address:** Enter the email address of the sender.
- **Recipient email address:** Enter the email address of the recipient.
- **Server address:** Enter the domain name or IP address of the email server.
- **User name:** Enter the user name of the email account if necessary.
- **Password:** Enter the password of the email account if necessary.
- **Server port:** The default mail server port is set to 25. You can also manually set another port.

If your SMTP server requires a secure connection (SSL), check "This server requires a secure connection (SSL)".

To verify if the email settings are correctly configured, click Test. The result will be shown in a pop-up window. If successful, you will also receive an email indicating the result.

Click Save server to enable the settings.

Note that after you set up the first event server, the new event server will automatically display on the Server list. If you wish to add other server options, click Add server again.

Event name:

Enable this event

Priority: Normal

Detect next event after second(s).

1. Schedule

↓

2. Trigger

↓

3. Action

Action

Server	Media	Extra parameter
<input type="checkbox"/> SIP outgoing		
<input type="checkbox"/> FTP	-----None----- <input type="button" value="v"/>	
<input type="checkbox"/> Email	-----None----- <input type="button" value="v"/>	
<input type="checkbox"/> Http server	-----None----- <input type="button" value="v"/>	
<input type="checkbox"/> NAS	-----None----- <input type="button" value="v"/>	<input type="checkbox"/> Create folders by date time and hour automatically

[View](#)

Server type - FTP

Select to send the media files to an FTP server when a trigger is activated.

FTP

Server address:

Server port:

User name:

Password:

FTP folder name:

Passive mode

- **Server name:** Enter a name for the server setting.
- **Server address:** Enter the domain name or IP address of the FTP server.
- **Server port:** By default, the FTP server port is set to 21. It can also be assigned to another port number between 1025 and 65535.
- **User name:** Enter the login name of the FTP account.
- **Password:** Enter the password of the FTP account.
- **FTP folder name:** Enter the folder where the media file will be placed. If the folder name does not exist, the KX-NTV150/KX-NTV160 will automatically create a folder on the FTP server.
- **Passive mode:** Most firewalls do not accept new connections initiated from external requests. If the FTP server supports passive mode, select this option to enable passive mode FTP and allow data transmission to pass through the firewall. The firmware default has the Passive mode checkbox selected.

To verify if the FTP settings are correctly configured, click Test. The result will be shown in a pop-up window. If successful, you will also receive a test.txt file on the FTP server.

Click Save server to enable the settings.

Server type - HTTP

Select to send the media files to an HTTP server when a trigger is activated.

HTTP

URL:	<input type="text" value="http://192.168.6.141/test.cgi"/>
User name:	<input type="text" value="Panasonic"/>
Password:	<input type="password" value="•••••"/>

- **Server name:** Enter a name for the server setting.
- **URL:** Enter the URL of the HTTP server.
- **User name:** Enter the user name if necessary.
- **Password:** Enter the password if necessary.

To verify if the HTTP settings are correctly configured, click Test. The result will be shown in a pop-up window. If successful, you will receive a test.txt file on the HTTP server.

Click Save server to enable the settings.

Server type - Network storage:

Select to send the media files to a network storage location when a trigger is activated. Please refer to NAS server on page 125 for details.

Server type - SIP Outgoing

Select to make SIP outgoing to the number set in SIP → General settings.

SIP Outgoing

Click Save server to enable the settings.

Action

Server	Media	Extra parameter
Add server	Add media ▼	
<p>Server name: <input type="text"/></p> <p>Server type</p> <p><input type="radio"/> Email</p> <p><input type="radio"/> FTP</p> <p><input checked="" type="radio"/> HTTP</p> <p> URL: <input type="text" value="http://"/></p> <p> User name: <input type="text"/></p> <p> Password: <input type="password"/></p> <p><input type="radio"/> Network storage</p> <p><input type="radio"/> SIP Outgoing</p> <p style="text-align: right;"><input type="button" value="Test"/> <input type="button" value="Save server"/> <input type="button" value="Close"/></p>		

Add media

Click Add media to open the media setting window. You can specify the type of media that will be sent when a trigger is activated. A total of 5 media settings can be configured. There are three choices of media types available: Snapshot, Video clip, and System log. Select the item to display the detailed configuration options. You can configure either one or all of them.

The screenshot shows the 'Add media' configuration window. At the top, there are two tabs: 'Add server' and 'Add media'. Below the tabs is a 'Media name:' input field. The main section is titled 'Media type' and contains three radio button options: 'Snapshot' (selected), 'Video clip', and 'System log'. Under the 'Snapshot' option, there are two 'Send' fields: 'Send 1 pre-event image(s) [0~7]' and 'Send 1 post-event image(s) [0~7]'. Below these is a 'File name prefix:' input field and a checkbox labeled 'Add date and time suffix to file name'. At the bottom right of the window are 'Save media' and 'Close' buttons.

Media type - Snapshot

Select to send snapshots when a trigger is activated.

- **Media name:** Enter a name for the media setting.
- **Source:** Select to take snapshots from stream 1-2.
- **Send pre-event images:** The KX-NTV150/KX-NTV160 has a buffer area; it temporarily holds data up to a certain limit. Enter a number to decide how many images to capture before a trigger is activated. Up to 7 images can be generated.
- **Send post-event images:** Enter a number to decide how many images to capture after a trigger is activated. Up to 7 images can be generated. For example, if both the Send pre-event images and Send post-event images are set to 7, a total of 15 images are generated after a trigger is activated.

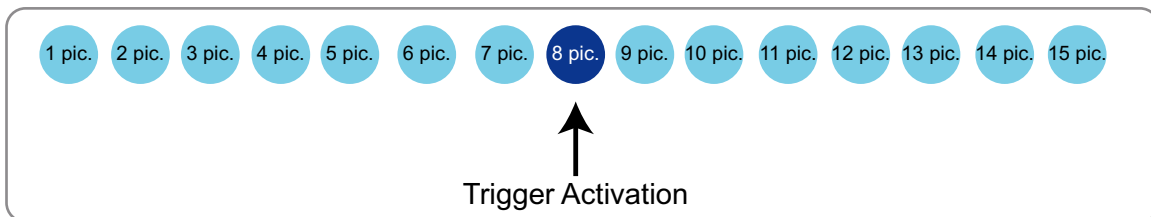

- **File name prefix:** Enter the text that will be appended to the front of the file name.
- **Add date and time suffix to file name:** Select this option to add a date/time suffix to the file name. For example:

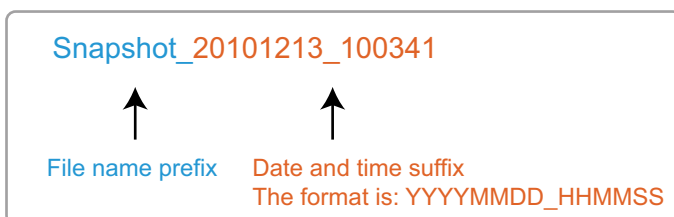

Click Save media to enable the settings.

To note that after you set up the first media server, a new column for media server will automatically show up on the Media list. If you wish to add more other media options, click Add media.

Media type - Video clip

Select to send video clips when a trigger is activated.

- **Media name:** Enter a name for the media setting.
- **Source:** Select the source of video clip.
- **Pre-event recording:** The KX-NTV150/KX-NTV160 has a buffer area; it temporarily holds data up to a certain limit. Enter a number to decide the duration of recording before a trigger is activated. Up to 9 seconds can be set.
- **Maximum duration:** Specify the maximum recording duration in seconds. Up to 20 seconds can be set. For example, if pre-event recording is set to five seconds and the maximum duration is set to ten seconds, the KX-NTV150/KX-NTV160 continues to record for another 4 seconds after a trigger is activated.

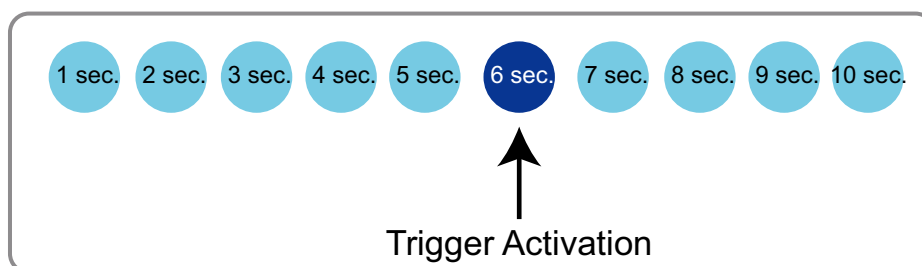

- **Maximum file size:** Specify the maximum file size allowed.
- **File name prefix:** Enter the text that will be appended to the front of the file name. For example:



Click Save media to enable the settings.

Media type - System log

Select to send a system log when a trigger is activated.

The screenshot shows a configuration form for media types. At the top, there are two buttons: 'Add server' with a dropdown arrow and 'Add media'. Below these is a 'Media name' input field. The main section is titled 'Media type' and contains the label 'Attached media:'. Underneath, there are three radio button options: 'Snapshot', 'Video clip', and 'System log'. The 'System log' option is selected. At the bottom right of the form, there are two buttons: 'Save media' and 'Close'.

Click Save media to enable the settings, then click Close to exit the page.

The screenshot shows a table titled 'Action' with three columns: 'Server', 'Media', and 'Extra parameter'. The 'Server' column has a checkbox for 'NAS'. The 'Media' column has a dropdown menu currently open, showing the following options: 'None', 'mySystemLog', 'mySnapshot', and 'myVideoClip'. There is a 'View' link next to the dropdown. The 'Extra parameter' column has a checkbox for 'Create folders by date time and hour automatically'. At the bottom left, there are buttons for 'Add server' and 'Add media'.

In the Event settings column, the Servers and Media you configured will be listed; please make sure the Event → Status is indicated as ON, in order to enable the event triggering action. When completed, click Save event to enable the settings and click Close to exit Event settings page. The new Event/Server settings/Media will appear in the event drop-down list on the Event settings page.

Please see the example of the Event setting page below:

Event

Name	Status	Sun	Mon	Tue	Wed	Thu	Fri	Sat	Time	Trigger	
Event1	ON	V	V	V	V	V	V	V	00:00~24:00	motion	<input type="button" value="Delete"/>

[Help](#)

Server settings

Name	Type	Address/Location	
NAS	ns	\\panasonic	<input type="button" value="Delete"/>
FTP	ftp	ftp.panasonic.com	<input type="button" value="Delete"/>
SIP outgoing	sip	server_i2_place	<input type="button" value="Delete"/>
Email	email	smtp.panasonic.com	<input type="button" value="Delete"/>
HTTPserver	http	http://192.168.6.141/test.cgi	<input type="button" value="Delete"/>

Media

Available memory space: 17100KB

Name	Type	
mySystemLog	systemlog	<input type="button" value="Delete"/>
mySnapshot	snapshot	<input type="button" value="Delete"/>
myVideoClip	videoclip	<input type="button" value="Delete"/>

When the Event Status is ON, once an event is triggered by motion detection, the KX-NTV150/KX-NTV160 will automatically send snapshots via e-mail.

If you want to stop the event trigger, you can click ON to turn it to OFF status or click Delete to remove the event setting.

To remove a server setting from the list, select a server name from the drop-down list and click Delete. Note that you can only delete a server setting when it is not applied to an event setting.

To remove a media setting from the list, select a media name from the drop-down list and click Delete. Note that you can only delete a media setting when it is not applied to an event setting.

2.15 Applications

2.15.1 Motion detection

This section explains how to configure the KX-NTV150/KX-NTV160 to enable motion detection. A total of five motion detection windows can be configured.

Enable motion detection

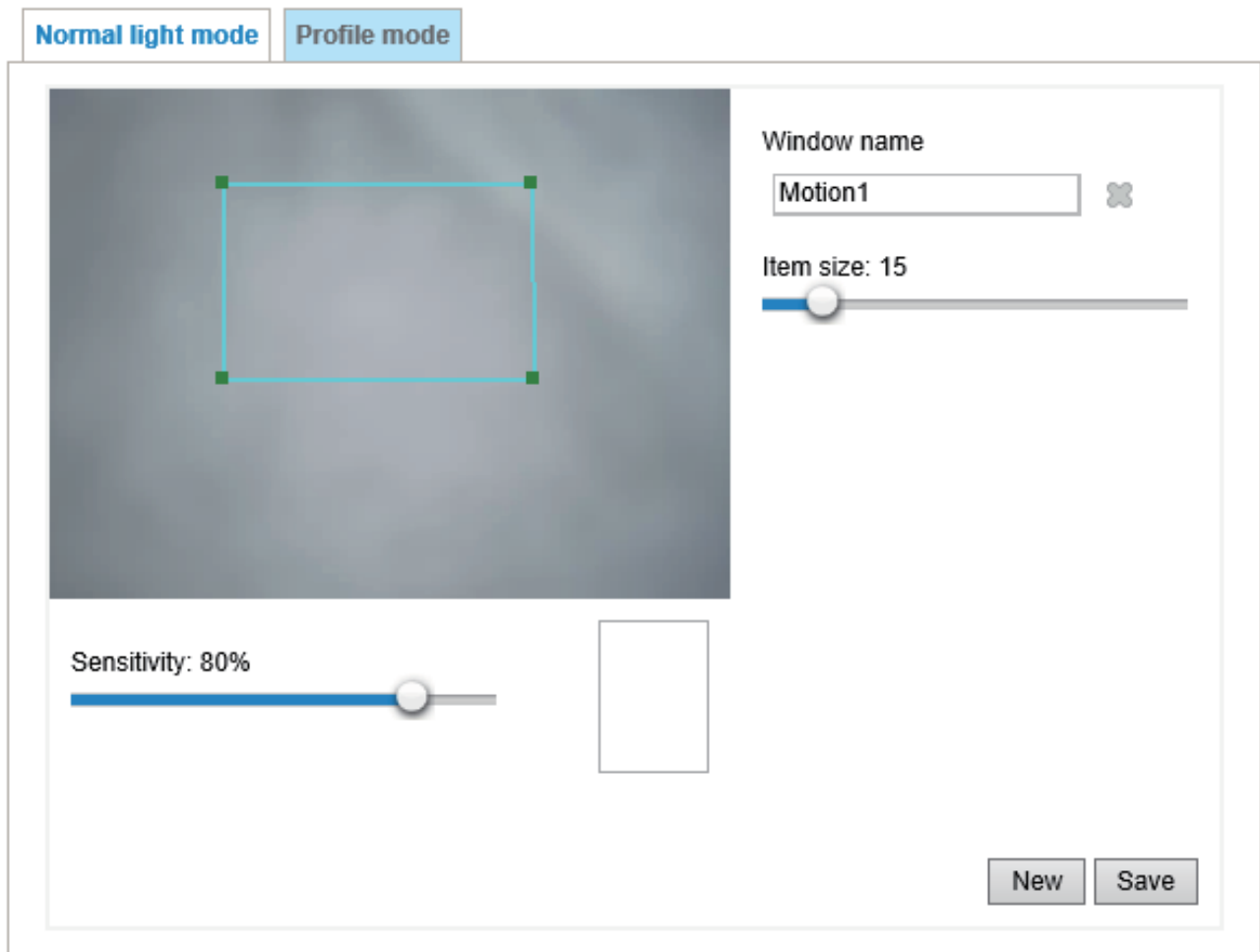

Follow the steps below to enable motion detection:

1. Click New to add a new motion detection window.
2. In the Window name text box, enter a name for the motion detection window.
 - To move and resize the window, drag and drop your mouse on the window with the quadrilateral shape.
 - To delete a window, click the X mark on the right of the window name.
3. Define the sensitivity to moving objects and the space ratio of all alerted pixels by moving the Sensitivity and Item size slider bar.
4. Click Save to enable the settings.
5. Select Enable motion detection to enable this function.

For example:

Enable motion detection

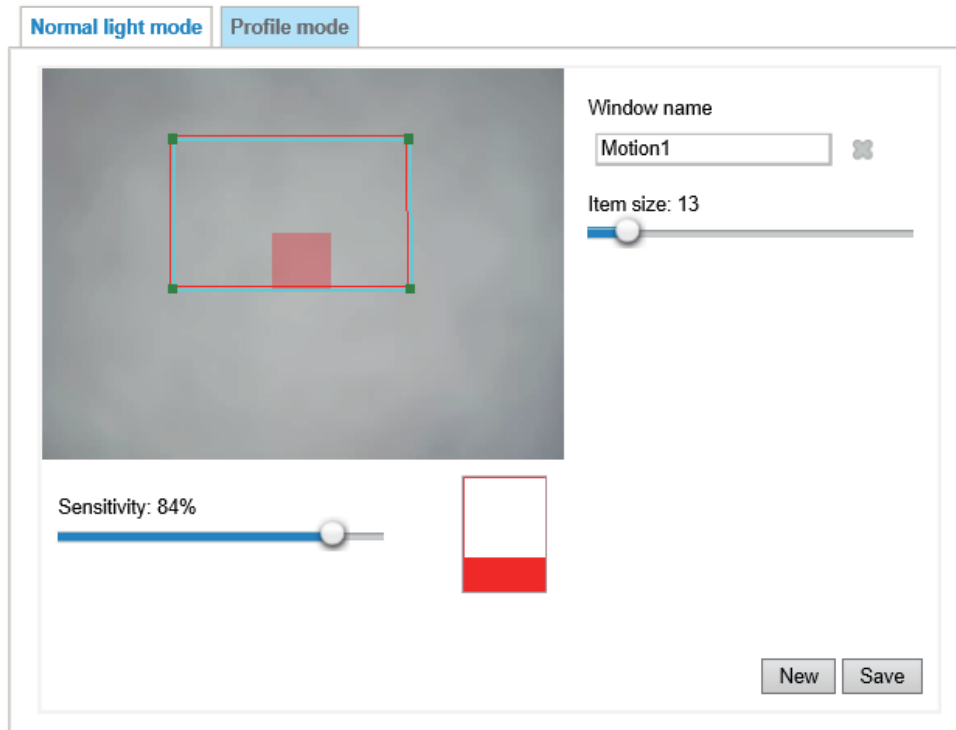

The Item size means the object you want to detect in the scene. The Sensitivity can control the detect threshold. If image vibration exceeds the threshold, the red bar rises. Meanwhile, the motion detection window will be outlined in red. Photos or videos can be captured instantly and configured to be sent to a remote server (Email, FTP) by utilizing this feature as a trigger source. For more information on how to set an event, please refer to Event settings on page 106.

A green bar indicates that even though motions have been detected, the event has not been triggered because the image variations still fall under the defined threshold.

If you want to configure other motion detection settings for a different time period within a day, please click Profile to open the Motion detection Profile Settings page as shown below. A total of five motion detection windows can be configured on this page as well.

Enable motion detection

Normal light mode Profile mode

Window name
Motion1

Item size: 15

Enable to apply these settings at

Schedule mode [hh:mm]
From 18:00 to 06:00

Sensitivity: 80%

New Save

Please follow the steps below to set up a profile and additional motion detection windows in it:

1. Create a new motion detection window.
2. Check Enable to apply these settings at.
3. Select the Schedule mode. Please manually enter a time range if you choose Schedule mode.
4. Click Save to enable the settings and click Close to exit the page.

This motion detection window will also be displayed on the Event Settings page. You can go to Event → Event settings → Trigger to configure it as a trigger source.

2.15.2 DI and DO

Panasonic Home Client settings Configuration Language

Applications > DI and DO

Digital input

Normal status: High Low

Current status: **High**

Digital output

Current status: **Open**

Make time: 1 2 3 4 5 6 7

Save

Version: 0101c1

Connect DI or DO devices to the terminal block of the KX-NTV150/KX-NTV160, the KX-NTV150/KX-NTV160 will automatically detect the current connection state as pulled-high or pulled-low. You may then define the triggering condition.

- **Digital input**
 - Normal status: Select "High" or "Low" to define the "Normal status" for the digital input.
 - Current status: Indicate the current status ("High" or "Low") on the digital input.
- **Digital output**
 - Current status: Indicate the current status on the digital output, and indicate "Open" normally.
 - Make time: Set the keeping time after the digital output is triggered. For example, if "Make time" is set to 5 seconds, when Digital output is triggered, it will keep "Grounded" status for 5 seconds.

2.15.3 Camera tampering detection

This section explains how to set up KX-NTV150/KX-NTV160 tamper detection. With tamper detection, the KX-NTV150/KX-NTV160 is capable of detecting incidents such as redirection, blocking or unfocusing, or even spray paint.

Camera tampering detection

Tampering detection

Trigger duration seconds [10~600]

Trigger threshold [0~100]

Image too dark detection

Trigger duration seconds [1~10]

Trigger threshold [0~100]

Image too bright detection

Trigger duration seconds [1~10]

Trigger threshold [0~100]

Image too blurry detection

Trigger duration seconds [1~10]

Trigger threshold [0~100]

Please follow the steps below to set up the KX-NTV150/KX-NTV160 tamper detection function:

1. Enter the tamper trigger duration (10 seconds-10 minutes). The tamper alarm will be triggered only when the tampering factor (the difference between current frame and pre-saved background) exceeds the trigger threshold. Conditions such as image too dark, too bright, or too blurry (unfocused) can also be configured as tampering conditions.
2. You can configure Tampering Detection as a trigger element to the proactive event configurations in Event → Event settings → Trigger. For example, when the KX-NTV150/KX-NTV160 is tampered with, KX-NTV150/KX-NTV160 can be configured to send pre- and post-event video clips to a networked storage device. Please refer to page 125 for detailed information.

2.15.4 Voice detection

Simply select High/Middle/Low threshold level for Voice detection.

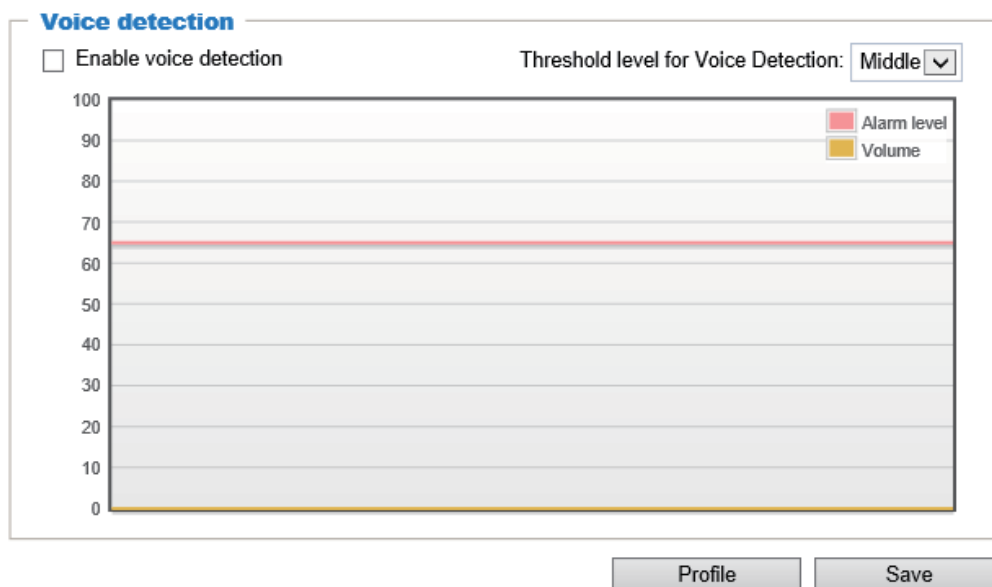

Voice detection, along with video motion detection, is applicable in the following scenarios:

1. Detection of activities not covered by camera view, e.g., a loud input by gun shots or breaking a door or window.
2. A usually noisy environment, such as a factory, suddenly becomes quiet due to a breakdown of machines.
3. A PTZ camera can be directed to turn to a preset point by the occurrence of audio events.
4. Dark environments where video motion detection may not function well.

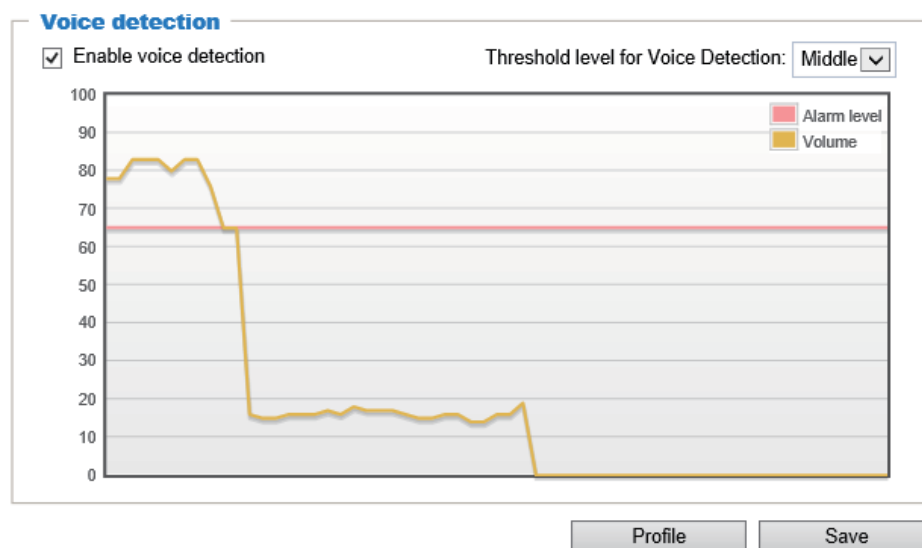

How to configure Voice detection:

1. Once the Voice detection window is opened, the current sound input will be interactively indicated by a fluctuating yellow wave diagram.
2. Select the alarm level from the drop-down list (High, Middle, or Low).
3. Select the "Enable voice detection" checkbox and click Save to enable the feature.

Note

- You can use the Profile window to configure a different Voice detection setting. For example, a place can be noisy in the day time and become very quiet in the night.
1. Click on the Enable this profile checkbox. Once the Voice detection window is opened, the current sound input will be interactively indicated by a fluctuating yellow wave diagram.
 2. Select the alarm level from the drop-down list (High, Middle, or Low).
 3. At Schedule mode, you can manually configure a period of time during which this profile will take effect.
 4. Click Save and then click Close to complete your configuration.

General settings

Enable this profile Threshold level for Voice Detection: ▾

This profile is applied to:

Schedule mode

From to [hh:mm]

2.16 Recording

2.16.1 Recording settings

This section explains how to configure the recording settings for the KX-NTV150/KX-NTV160.

Recording settings

Name	Status	Sun	Mon	Tue	Wed	Thu	Fri	Sat	Time	Source	Destination	Delete
<input type="button" value="Add"/>												

Recording Settings

Click Add to open the recording setting window. On this page, you can define the adaptive recording, recording schedule, and recording capacity. A total of 2 recording settings can be configured.

Recording name:

Enable this recording

With adaptive recording ([Help](#))

Priority: ▾

The diagram shows a flow from '1. Trigger' to '2. Destination'. The 'Trigger' section is expanded to show the following configuration:

Trigger

- Schedule
 - Sun Mon Tue Wed Thu Fri Sat
- Time**
 - Always
 - From to [hh:mm]

Note: To enable recording notification please configure [Event](#) first

Save

Close

- **Recording name:** Enter a name for the recording setting.
- **Enable this recording:** Select this option to enable video recording.
- **With adaptive recording:** Selecting this option will activate the frame rate control according to alarm trigger. The frame control means that when there is a triggered alarm, the frame rate will raise up to the value you've set on Video quality page.

If you enable adaptive recording on Camera A, only when an event is triggered on Camera A will the server record the full frame rate streaming data; otherwise, it will only request the I frame data during normal monitoring, thus effectively save lots of bandwidth and storage space.

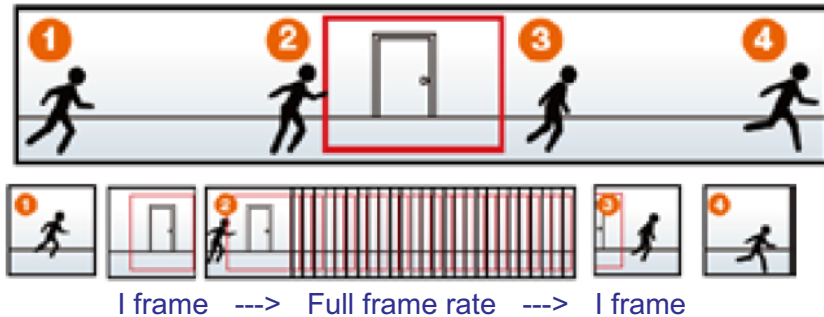

Bandwidth

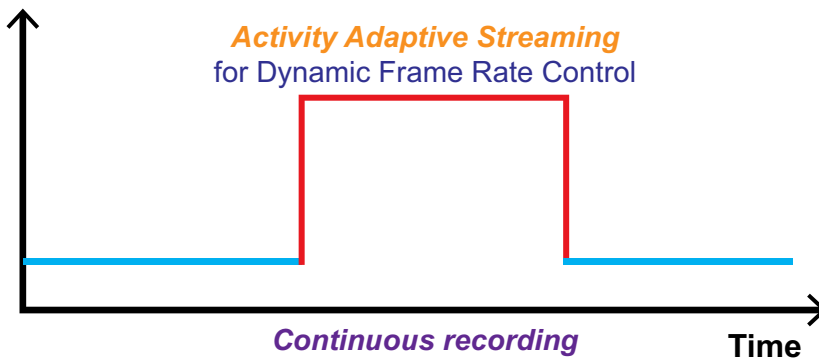

Note

- To enable adaptive recording, please make sure you've set up the trigger source such as Motion detection, DI Device, or Manual triggers.
- When there is no alarm trigger:
 - JPEG mode: record 1 frame per second.
 - H.264 mode: record the I frame only.
- When the I frame period is greater than 1s on Video settings page, firmware will force decrease the I frame period to 1s when adaptive recording is enabled.

The alarm trigger includes: motion detection, tampering detection, and DI detection. Please refer to Event settings on page 106.

- **Pre-event recording and post-event recording:** The KX-NTV150/KX-NTV160 has a buffer area (a flash memory); it temporarily holds data up to a certain limit. Enter a number to decide the duration of recording before and after a trigger is activated.
- **Priority:** Select the relative importance of this recording (High, Normal, or Low). Recording with a higher priority setting will be executed first.
- **Source:** Select a stream for the recording source.

Note

- To enable recording notification please configure Event settings first. Please refer to page 106.

Please follow the steps below to set up the recording.

1. Trigger

Trigger

Schedule

Sun Mon Tue Wed Thu Fri Sat

Time

Always

From to [hh:mm]

2. Schedule: The server will start to record files on the local storage or a networked storage (NAS).

3. Destination

You can select the network storage (NAS) for the recorded video files.

Recording name:

Enable this recording

With adaptive recording ([Help](#))

Priority: ▼

1. Trigger

↓

2. Destination

Destination

Destination: ▼

Capacity:

Entire free space

Reserved space: Mbytes

Enable cyclic recording

Recording file management

Maximum duration: minutes [1~60]

Maximum file size: MB [100~2000]

File name prefix:

Note: To enable recording notification please configure [Event](#) first

Save

Close

NAS server

If you have not configured a NAS server, click Add NAS server to open the server setting window and follow the steps below to set up:

1. Fill in the information for your server.

For example:

Server name:

Server type

Email

FTP

HTTP

Network storage

Network storage location:

(For example: \\my_nas\disk\folder)

Workgroup:

User name:

Password:

SIP Outgoing

2. Click Test to check the setting. The result will be shown in a pop-up window.

If successful, you will receive a test.txt file on the network storage server.

3. Enter a server name.

4. Click Save to complete the settings and click Close to exit the page.

Back to the Recording setup page, you can now record videos to the networked storage.

- **Capacity:** You can choose either the entire free space available or limit the reserved space. The recording size limit must be larger than the reserved amount for cyclic recording.
- **File name prefix:** Enter the text that will be appended to the front of the file name.
- **Enable cyclic recording:** If you check this item, when the maximum capacity is reached, the oldest file will be overwritten by the latest one. The reserved amount is reserved for the transaction stage when the storage space is about to be full and new data arrives. The minimum space for the reserved space must be larger than 15 MB.
- **Recording file management:** You can manually assign the Maximum duration and the Maximum file size for each recording footage. You may need to stitch individual files together under some circumstances. You may also designate a file name prefix by filling in the responsive text field.

Note

- To edit or remove an existing NAS setting, you have to turn OFF all related event or recording configuration.
- Please use NAS server instead of USB device.

Recording file management

- **Maximum duration (minutes):** Specifies the length of each of the recorded videos.
- **Maximum file size (MB-Megabytes):** Specifies the file size limitation of each recorded video. The duration and size are the upper thresholds. The limitation is imposed when either the length or the file size is reached. The recording then continues by creating other video files.
- **File name prefix:** You may enter a file name prefix for the recorded files.

If you want to enable recording notification, please click Event to configure event triggering settings. Please refer to Event → Event settings on page 106 for more details.

When completed, select Enable this recording. Click Save to enable the setting and click Close to exit this page. When the system begins recording, it will send the recorded files to the network storage. The new recording name will appear in the drop-down list on the recording page as shown below.

To remove a recording setting from the list, select a recording name from the drop-down list and click Delete.

Recording settings												
Name	Status	Sun	Mon	Tue	Wed	Thu	Fri	Sat	Time	Source	Destination	Delete
Video	ON	V	V	V	V	V	V	V	00:00~24:00	stream1	NAS	<input type="button" value="Delete"/>
<input type="button" value="Add"/>												

- **Click Video (Name):** Opens the Recording Settings page to modify.
- **Click ON (Status):** The Status will become OFF and stop recording.
- **Click NAS (Destination):** Opens the file list of recordings. For more information about folder naming rules, please refer to page 110 for details.

3 Specifications

3.1 Technical Specifications

3.1.1 General

Feature		KX-NTV150	KX-NTV160
Dimension (Protruding not included)	W x H x D (mm)	70.1 × 123.5 × 33.1	70.3 × 131.2 × 34
Weight		170 g	260 g
Body Color		White	Silver
Body Material		PC	ABS, Aluminum
Power Source	Using an AC adaptor (option parts)	AC input: 100 V-240 V, 50/60 Hz DC output voltage: +8.1 V to +9.9 V (average +9.0 V) DC output current: Max. 750 mA	N/A
	Using PoE	Based on IEEE802.3af, class2 (DC voltage: +36 V to +57 V)	
Power Consumption		Maximum: 3.9 W	Maximum: 3.2 W
Ambient Temperature	Operating range	0 °C to 40 °C	-10 °C to 50 °C
	Storage range	-10 °C to 50 °C	
Ambient Humidity	Operating range	20 % to 90 % (no condensation)	
	Storage range	20 % to 90 % (no condensation)	
Installation Method		put on the desk, fixed by stand,	wall mount

3.1.2 Camera Block

Feature		KX-NTV150/KX-NTV160
Image Sensor	Type	1/3.2" Progressive CMOS
Lens	Type	Fixed-focal
	Focal Length	f=2.8
	Aperture	F=1.8
	Focus Range	∞ to 0.2 m

Feature		KX-NTV150/KX-NTV160
Field of View (16:9)	Horizontal	92°
	Vertical	52°
	Diagonal	106°
Field of View (4:3)	Horizontal	92°
	Vertical	70°
	Diagonal	115°

3.1.3 Video (Live View Settings)

Feature		KX-NTV150/KX-NTV160
Number of Stream		3 (Stream1, Stream2, and Stream3) → Stream1: for RTSP, Stream2: for SIP Stream3: for setting video motion detection, thumbnail, etc. (Resolution is fixed to QVGA (320x240) and Stream3 cannot be configured on the WEB UI.)
Codec		Support H.264 and JPEG (only for RTSP) Setting by configuration menu on WEB access → select H.264 (Baseline, Level 4.1) or JPEG (only for RTSP)
Resolution		Setting by configuration menu on WEB access (Stream1 and Stream2) Select one: → 1600×1200, 1280×960, 1280×720, 1024×768, 640×480, 640×360, 386×216, 352×288, 320×240, 176×144
Frame rate	Maximum frame rate setting	Setting by configuration menu on WEB access (Stream1 and Stream2) Select one: → 5, 8, 10, 12, 15, 20, 25, and 30 fps
	Maximum performance	(Stream1 and Stream2) H.264: 30 fps at 1600x1200 30 fps at 1280x720 MJPEG: 30 fps at 1600x1200 30 fps at 1280x720

Feature		KX-NTV150/KX-NTV160
Video quality		(Stream1 and Stream2) Setting by configuration menu on WEB access Select one: → (H.264) CBR (constant bit rate): Target bit rate: 20 K, 30 K, 40 K, 50 K, 64 K, 128 K, 256 K, 512 K, 768 K, 1 M, 2 M, 3 M, 4 M, 6 M, 8 Mbps, and Customized (20 to 8000 Kbps) Policy: Select "Frame rate priority" or "Image quality priority" VBR (fixed quality): Quality: Medium, Standard, Good, Detailed, Excellent, and Customized (1 to 100%) Target bit rate: 1 M, 2 M, 3 M, 4 M, 6 M, 8 Mbps, and Customized (20 to 8000 Kbps) → (JPEG) (only for RTSP) Same as H.264 menu except for "Intra frame period"
Intra frame period	(H.264 only)	(Stream1 and Stream2) Setting by configuration menu on WEB access Select one: → 1/4, 1/2, 1, 2, 3, or 4 Sec

3.1.4 Audio

Feature	KX-NTV150/KX-NTV160
Microphone	Built-in MIC
Speaker	Built-in Speaker
Echo Canceller	Include function of echo canceller
Mute for Microphone	Setting by configuration menu on WEB access → ON/OFF
Volume control for Microphone	Setting by configuration menu on WEB access → level tuning
Mute for Speaker	Setting by configuration menu on WEB access → ON/OFF
Volume control for Speaker	Setting by configuration menu on WEB access → level tuning

Feature	KX-NTV150/KX-NTV160
Codec	Support G.711 (a-law/u-law), G.722 (only for SIP), G.729a (only for SIP) Setting by configuration menu on WEB access → Select G.711 (a-law/u-law), G.722 (only for SIP), or G.729a (only for SIP)

3.1.5 External I/O port

Feature	KX-NTV150/KX-NTV160
Digital Input (DI)	1 ch
Digital Output (DO)	1 ch <ul style="list-style-type: none"> output current: Max. -100 mA applied voltage: Max. +50 V

3.1.6 SIP Terminal Features

Feature	KX-NTV150/KX-NTV160
Power Supply	AC Adaptor (only KX-NTV150) PoE (IEEE 802.3 af)
Network Interface	1 × RJ45 10Base-T/100BaseTx
PLC (Packet Loss Concealment)	Yes
Echo Cancellation	Yes
Wideband Codec	G.722
Narrowband Codec	G.711a-law/G.711u-law/G.729a
Packet Time	20 ms/30 ms/40 ms
Dial Key (DTMF)	Accept Out band (RFC2833)/SIP INFO*1 *1 Operations depend on the model and version of the PBX and the version of the KX-NTV150/KX-NTV160. You can confirm compatibility and download related documentation on the Panasonic Web site at: http://www.panasonic.net/pcc/support/pbx/
TONE	Yes (BUSY TONE/RING BACK TONE/REORDER TONE/KEY TONE/CONFIRMATION TONE)

3 Specifications

Feature	KX-NTV150/KX-NTV160
Embedded WEB GUI Language	English Spanish French Italian German Portuguese Russian Canadian French
Auto provisioning: DHCP option	Yes [DHCPv4] Option 66
Provisioning: Configuration file	Yes Plain Text format
Provisioning: WEB GUI	Yes
Export Current Active Settings	Yes
Manual Firmware Upgrade	Yes
Reboot	Yes (Web GUI)
Reset to factory default	Yes (Web GUI/Reset button)
Embedded WEB Server	Yes OS: Windows 7/8/10 Browser: Internet Explorer 7/Internet Explorer 8/Internet Explorer 9/Internet Explorer 10/Internet Explorer 11/Firefox
Embedded WEB Accounts	20 admin/operator/Viewer
Embedded WEB Access Restriction	10 user
IP Stack mode	IPv4 only
Network Addressing	Static IPv4/Dynamic IPv4
ICMPv4/ICMPv6	Yes/No
PINGv4/PINGv6	Yes/No
DHCPv4/DHCPv6 (with Options)	Yes/No
FTP/TFTP/HTTP/HTTPS	Yes
HTTP server	Yes
RTP/RTCP	Yes
SNTP	Yes
Syslog	Yes
IGMPv3	Yes
SNMPv1/v2/v3	Yes
Attack IP Packet Protection	Yes

Feature	KX-NTV150/KX-NTV160
IEEE802.1x	Yes
QoS	Yes
Digest Authentication using MD5	Yes
AES Key Sizes	128/192/256 bits
RSA Key Sizes	2048/4096 bits
WIFI WEP	64 bit/128 bit (only KX-NTV150)
WIFI WPA(TKIP/AES)	Yes (only KX-NTV150)
WIFI WPA2(TKIP/AES)	Yes (only KX-NTV150)

4 Appendix

SIP Settings			
PHONE_NUMBER_1	STRING	Up to 32 characters (only 0-9*#ABCDPFT()-[])	
SIP_RGSTR_ADDR_1	STRING	Up to 127 characters (only 0-9, A-Z, a-z, -, .)	
SIP_RGSTR_PORT_1	US-INTEGER	1 to 65535	
SIP_PRXY_ADDR_1	STRING	Up to 127 characters (only 0-9, A-Z, a-z, -, .)	
SIP_PRXY_PORT_1	US-INTEGER	1 to 65535	
SIP_SVCDOMAIN_n	STRING	Up to 95 characters (only 0-9, A-Z, a-z, -, .)	
SIP_AUTHID_1	STRING	Up to 32 characters (only 0-9*#ABCDPFT()-[])	
SIP_PASS_1	STRING	Max. 127 characters (except ", &, ', :, <, >, and space)	
REG_RTX_INTVL_1	US-INTEGER	10 to 86400	
SIP_OUTGOIN_NUMBER	STRING	Up to 32 characters (only 0-9*#ABCDPFT()-[])	
RTP Settings			
RTP_PTIME	US-INTEGER	20, 30, 40	
NTP Settings			
NTP_ADDR	STRING	Up to 175 characters (except ", &, ', <, >)	
TIME_QUERY_INTVL	US-INTEGER	10 to 86400	
Time Settings			
TIME_ZONE	S-INTEGER	(min) -720, -660, -600, -540, -480, -420, -360, -300, -240, -210, -180, -120, -60, 0, 60, 120, 180, 210, 240, 270, 300, 330, 345, 360, 390, 420, 480, 540, 570, 600, 660, 720, 780	
DST_ENABLE	BOOLEAN	Y: Enable N: Disable	
DST_OFFSET	US-INTEGER	0-720 (min)	
DST_START_MONTH	US-INTEGER	1-12	
DST_START_ORDINAL_DAY	US-INTEGER	1-5 (1: the first week of the month, 2: the second week of the month, ..., 5: last week of the month)	

	DST_START_DAY_OF_WEEK	US-INTEGER	0-6 (0: Sun, 1: Mon, ...,6: Sat)
	DST_START_TIME	US-INTEGER	0-1380 (min) KX-NTV150/KX-NTV160 setting only per hour (ex. 0, 60, 120, 180, ..., 1380)
	DST_STOP_MONTH	US-INTEGER	1-12
	DST_STOP_ORDINAL_DAY	US-INTEGER	1-5 (1: the first week of the month, 2: the second week of the month, ..., 5: last week of the month)
	DST_STOP_DAY_OF_WEEK	US-INTEGER	0-6 (0: Sun, 1: Mon, ..., 6: Sat)
	DST_STOP_TIME	US-INTEGER	0-1380 (min) KX-NTV150/KX-NTV160 setting only per hour (ex. 0, 60, 120, 180, ..., 1380)
NAT Settings			
	PORT_PUNCH_INTVL	US-INTEGER	0,10 to 300 0: Disable

4.1 Entering Characters

In the Web user interface, when specifying a name, message, password, or other text item, you can enter any of the ASCII characters displayed in the following table.

	00	01	02	03	04	05	06	07	08	09	0A	0B	0C	0D	0E	0F
20	SP	!	"	#	\$	%	&	'	()	*	+	,	-	.	/
30	0	1	2	3	4	5	6	7	8	9	:	;	<	=	>	?
40	@	A	B	C	D	E	F	G	H	I	J	K	L	M	N	O
50	P	Q	R	S	T	U	V	W	X	Y	Z	[\]	^	_
60	`	a	b	c	d	e	f	g	h	i	j	k	l	m	n	o
70	p	q	r	s	t	u	v	w	x	y	z	{		}	~	

Panasonic System Networks Co., Ltd.

1-62, 4-chome, Minoshima, Hakata-ku, Fukuoka 812-8531, Japan
<http://www.panasonic.com/>

Panasonic Corporation of North America

Two Riverfront Plaza, Newark, NJ 07102-5490
<http://www.panasonic.net/pcc/support/pbx/>

Panasonic Canada Inc.

5770 Ambler Drive, Mississauga, Ontario, L4W 2T3
<http://www.panasonic.com/ca/>

Copyright:

This material is copyrighted by Panasonic System Networks Co., Ltd., and may be reproduced for internal use only. All other reproduction, in whole or in part, is prohibited without the written consent of Panasonic System Networks Co., Ltd.

© Panasonic System Networks Co., Ltd. 2016

PNQX7581WA PP0116YY3066